

LINTELOO

The feel good **factor**



'LINTELOO IS
ALL ABOUT
COMFORT
AND
THE JOY
OF LIFE'





LINTELOO was founded in 1994 by Jan te Lintelo and is known for **‘the feel good factor’** connecting passionate people from around the world. The creativity of the designers and dialogue throughout the product development is key to a successful collection.

LINTELOO STORY

LINTELOO

In 1994, more than fifteen years before trend forecaster Lidewij Edelkoort declared ‘well-being’ one of the most important international trends, Jan te Lintelo (b. 1954) started a brand that radiates ‘enjoying the good life’ in every possible way. Raised by parents who owned a furniture store in the Netherlands, and having worked for Dutch design companies Pastoe, Rohé and Gelderland, he had noticed the domination of minimalism in the early nineties. British and Italian design gurus were promoting an anonymous, sterile interior style in which practically anything personal was hidden in cupboards, and anything ‘comfortable’ expelled to the bedroom. ‘I always said “let’s make a very big sofa! And why not add some comfortable footstools and extra cushions?” The reply was always: “That won’t sell.” So he decided to produce one himself.

LINTELOO’s first international success was the now classic sofa Easy Living, which Jan te Lintelo designed himself. It is a simply shaped sofa that is extremely comfortable, due to its solid materials, sumptuous fabrics and ergonomic intelligence. ‘Our collection has just that little bit more in size and fabrics with matching cushions’. For example, we use beautiful leathers that are tanned in a natural way and gorgeous to the touch.’ ‘Do sit down,’ Jan tells

visitors arriving in his showroom. ‘How does that feel? Comfortable isn’t it?!’

LINTELOO’s corporate colour is bright orange, reflecting its Dutch roots, though nowadays designs by LINTELOO are sold all over the world. The company, with its head office and showroom in Zeist, has more than 250 dealers worldwide and permanent showrooms in Cologne and Zeist. The cosmopolitan flair of the collection can be attributed to a collaboration with internationally renowned designers like Paola Navone, Niels Bendtsen, Anders Nørgaard, Jan des Bouvrie, Roderick Vos, Sebastian Herkner and Yabu Pushelberg. A part of the collection is designed by Jan te Lintelo.

Over the years, LINTELOO has produced a series of successful designs that are still very much in demand today. ‘The collection as a whole doesn’t have to radiate a single rigid style,’ Jan explains, ‘as long as all the items are related to one another, like family. That’s why I am so happy with the designers I work with. They don’t all have the same signature, but they do all share the same philosophy. They work hard and think out of the box, while respecting traditional craftsmanship. And they all enjoy life as much as I do.’



CUBO LIGHT

2018 JOENY VELDHUYZEN VAN ZANTEN

Joeny's 'Cubo' lamp is a true statement piece. No two 'Cubos' are the same, with their character defined by the swirls, bubbles and imperfections that come with artisanal, mouth-blown glass. Perfect for ambient lighting, the 'Cubo' is as beautiful 'on', as it is 'off' – Dutch design and craftsmanship at its best.

LINTELOO



MAURO

2007 JAN TE LINTELO

SPECS
PAGE 118

With 'relaxation guaranteed' as a promise, Jan te Lintelo designed an extensive seating system; the Mauro. Elegant but yet generously sized for your comfort. The sofa has become a real LINTELOO-icon, as it is a bestseller from the very beginning. Also available as an armchair, in both fabric and leather upholstery.





LINTELOO

OBI

2006 **RODERICK VOS**

Overstating the conventional form of a Balinese offering plate, gave designer Roderick Vos the inspiration for this playful series of coffee tables with an appropriate size for every purpose. Made of birch plywood, available in anthracite, oriental brown or lacquered in Pure White. Other RAL colours available on request.

LINTELOO



NUREYEV

2008 RODERICK VOS

Roderick Vos' rotating 'book carousel' is an elegant, decorative and a practical bookcase, named after the legendary Russian dancer Rudolf Nureyev. Between the functional compartments, you can look through the bookcase. Frame is in MDF and birch multiplex, lacquered in RAL 9010 (other colours on request).





JAN
TE
LINTELO

LINTELO

Jan te Lintelo (1954) was born into a family of furniture retailers in Haaksbergen in the eastern part of The Netherlands. Growing up surrounded by the beautiful furniture at his parents shop he understood the skills and great craftsmanship of artisans and architects at an early age.

Jan studied furniture manufacturing focussing on craftsmanship and creativity but also the entrepreneurship of the trade. He worked in sales for Dutch cabinetmaker Pastoe and the famous upholstery factory Gelderland. In 1994 he decided to start his own company and create his own collection of furniture.

Using his experience in manufacturing combined with the feedback and wishes from his clients he designed the first collection himself and fast becoming one of the most successful modern furniture collections. His modern designs are characterized by great craftsmanship.

MORENO

2018 JAN TE LINTELO

LINTELOO

Inspired by Italian movies from the 1960's, this elegant new sofa by Jan te Lintelo is available in different sizes, all with great attention to detail. Refined stitching on the seat and back cushions in combination with the fabric and leather options from our exclusive collection create personalized and bespoke seating.

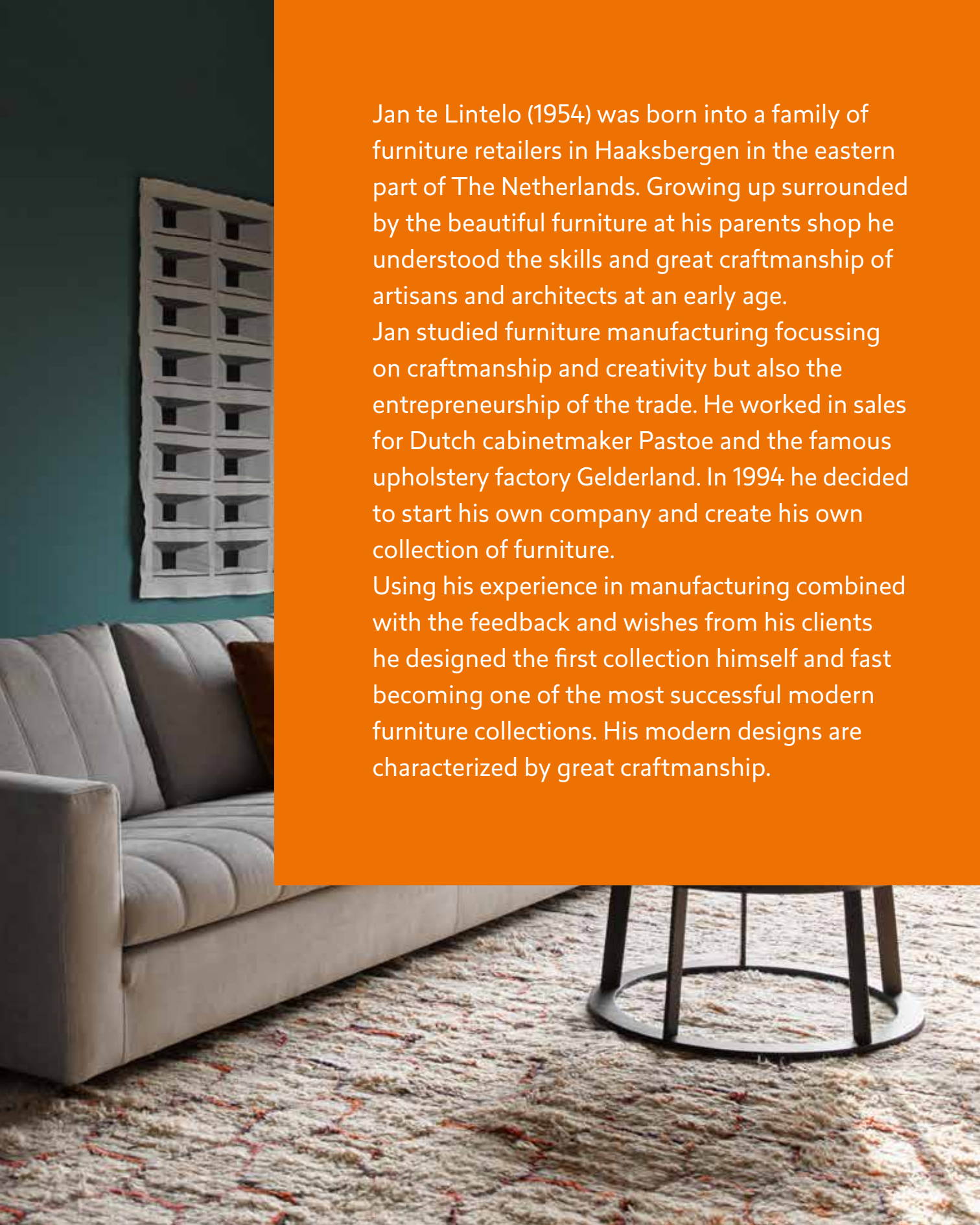

MADISON

2018 JAN TE LINTELO

LINTELOO

The modern design of this versatile and modular sofa, designed by Jan te Lintelo, allows you to create multiple compositions with cushions in several sizes and different armrests. This model refers to the cosmopolitan lifestyle in hotels and restaurants around the Madison Square Park in New York.







LINTELOO

CONVERSE

2007 FAAS VAN DIJK

Thanks to the surprising asymmetry and perfect proportions the table is a real piece of art. Its variety of visual directions enables the functional design to fit almost any room.



Jan des Bouvrie (1942) is a household name in the Netherlands. His parents owned a furniture shop in Bussum. After graduating from the Rietveld Academy in Amsterdam, he developed his signature style with clean lines and a lot of white. Jan des Bouvrie made design affordable and more familiar to the general public. He not only designs furniture but also industrial products, and he carries out interior and architectural projects all over the world. Both Jan himself and many of his designs have won prestigious prizes. In 1993, he and his wife Monique established 'Het Arsenaal' a leading interior and lifestyle store, where Jan has his design studio.

ANDY

2018 JAN DES BOUVRIE

LINTELOO

The new sofa by Jan des Bouvrie is made with a minimal use of elements, being the seat, arm and back cushions and the optional ottoman for a comfortable soft way of seating. Choose the number of seats, add the armrests and backs to create the perfect size. The design and comfort is our contemporary and generous version of the typical 'dutch' sofa.

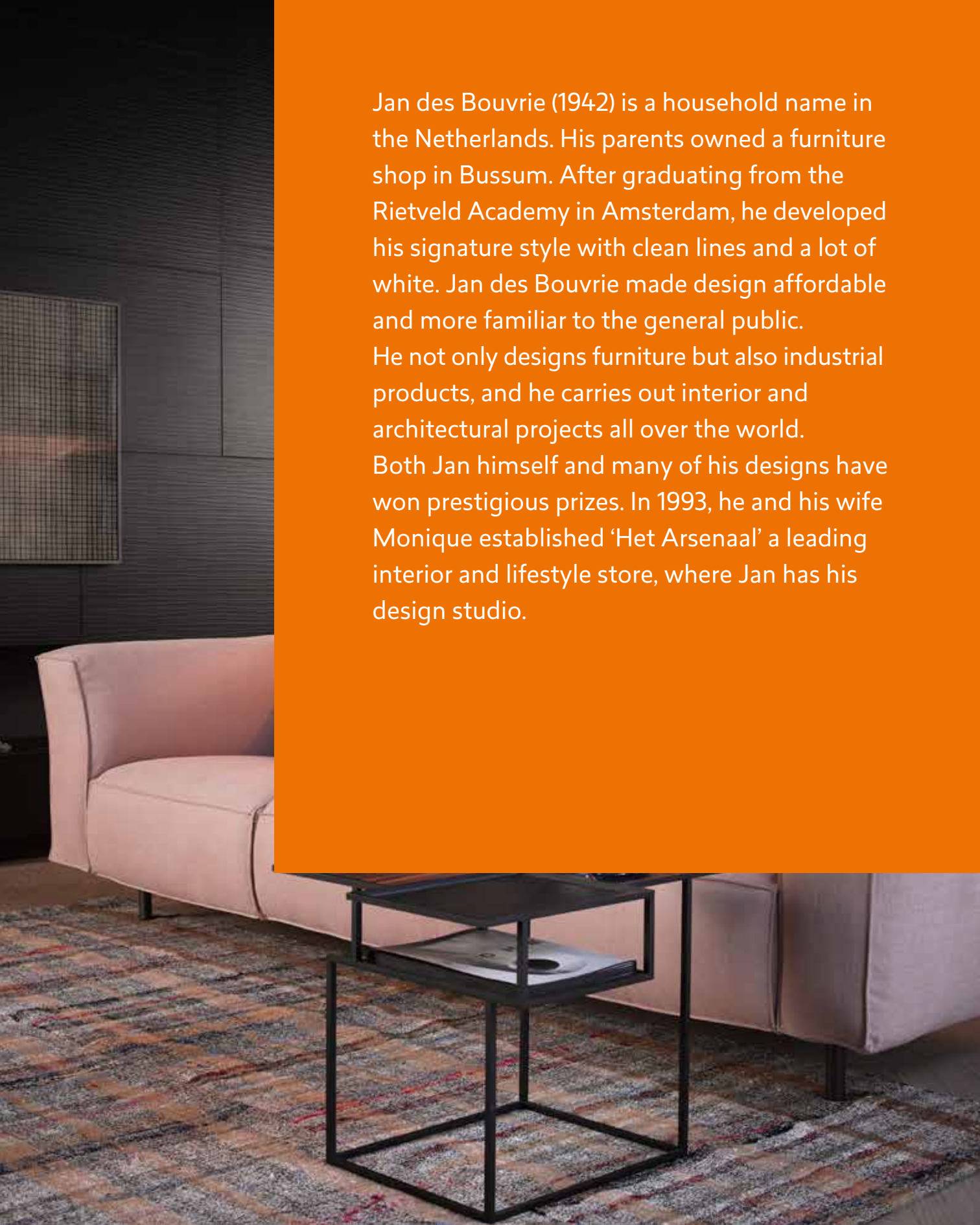

LINTELOO

GEORGE

2019 JAN TE LINTELO

The new sofa 'George' by Jan te Lintelo is inspired by the lifestyle of the people living around lake Como. It is defined by the floating modern look high from the ground combined with generous cushions and a high back for extra support and comfort.



ARP

2018 SEBASTIAN HERKNER

Arp Sofa was inspired by the roundness of Sculpture des Silence by Hans Jean Arp. This modular sofa's shape appears soft and harmonious. Each element can stand unaccompanied, or amongst arrangements with other pieces.

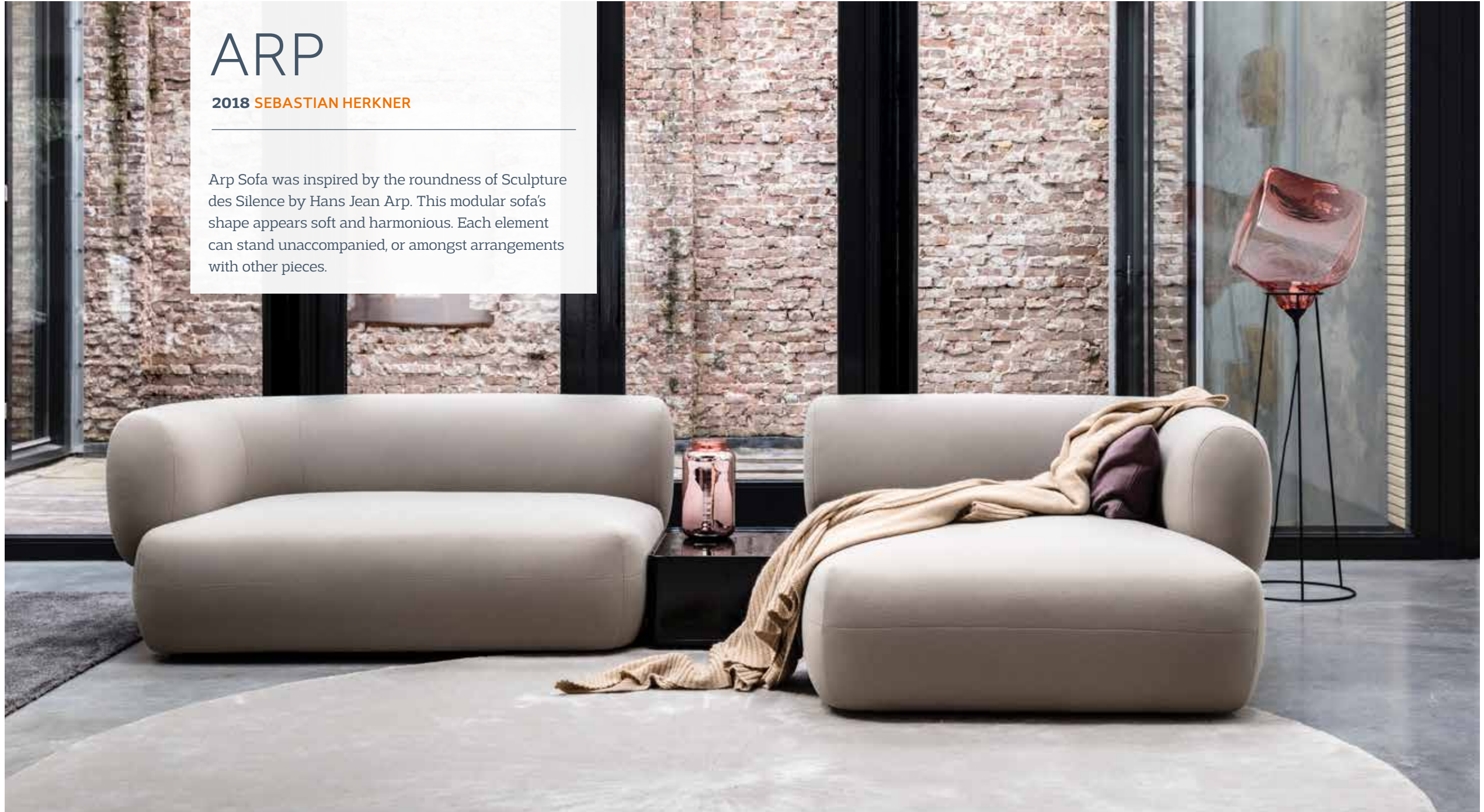



MANHATTAN

2012 RODERICK VOS

LINTELOO

Inspired by the art of Piet Mondriaan and the Russian Constructivism, Roderick Vos designed coffee table Manhattan as a landscape formation that requires the user to experiment and rediscover its function. A beautiful composition that is much more practical than expected. Made of birch plywood with smoked oak veneer.



LINTELOO



ALTO

2017 DAN YEFFET

Dan's Alto Light is designed as objects of desire – chic and pure. The Alto Light is composed of different glass pieces that are separated by an elegant silhouette of brass compiling the glass domes onto a carefully crafted marble base outputting a vertical light cloud.



DAN YEFFET

Born in 1971 in Jerusalem, Israel. Dan Yeffet studied Industrial Design at Bezalel Academy: School of Art and Design in Jerusalem (1999 - 2001). He then moved to the Netherlands where he graduated from the Gerrit Rietveld Academy in Amsterdam in 2002 (BA in industrial / product design). After his graduation he set up his studio in Amsterdam. In 2005 he moved his studio to Paris where he still works.

Dan's work stretches from space to objects - and everything in between - and in various methods, from classic craft work to cutting edge technologies. He designs furniture pieces, glass sculptures and lights, objects of desire - chic and pure - daily products, conceptual space, urban spaces, gallery objects and limited series. His work can be described as innovative, simple and yet with a strong identity.

BALANCED

2017 DAN YEFFET

The Balanced Side Tables are full of contradictions: warm and cold, thick and thin, flat and curved. The tables were made using wood and glass.



DARIO

2008 JAN TE LINTELO

LINTELOO

Timeless, inviting and comfortable. Jan te Lintelo's Dario is characterized by its elegant roundings and tight lines. The frame consists of beautiful and sophisticated American walnut. Available as armchair and / or footstool in both fabric and leather upholstery.

A new version in teak is now available in a range of outdoor fabrics and perfect as a very comfortable seating option for your veranda or terrace. The natural honest combination of materials is perfect for outdoor living.



DARIO OUTDOOR

2019 JAN TE LINTELO

AMPLE

2016 SEBASTIAN HERKNER

LINTELOO

This upholstered wing-armchair (also available with ottoman) has a strong silhouette and character as much as it is cosy. The padded seat is placed on a wooden structure and the soft cushioning gives you the feeling of an intimate place with many possible seating positions. Available in both fabric and leather upholstery.





LINTELOO

TERRACE

2016 SEBASTIAN HERKNER

This family of side and coffeetables by Sebastian Herkner is inspired by the arrangement of the countryside and the layout of fields. The table tops are made of different hand-made ceramic plates. Because of the various levels and surfaces, the color will slightly change its attitude from each perspective. Available in different sizes and colours.



SEBASTIAN HERKNER

LINTELOO





Born in 1981, Sebastian Herkner studied product design at the Offenbach University of Art & Design, focusing on designing objects and furniture by merging various cultural contexts, combining new technologies with traditional craftsmanship to highlight the multifaceted beauty of the materials and draw attention to fine details. Since founding his own design studio in Offenbach am Main in 2006, Sebastian has designed products for brands such as ClassiCon, Gervasoni and Moroso. He also works on interior design projects and presentations for exhibitions and museums. His designs have received numerous prizes.

HIGHLINE

2017 SEBASTIAN HERKNER

LINTELOO

Highline is an upholstered landmark by LINTELOO. Overlapping cushions and a slim base characterize this new sofa by bringing a new approach of comfort. It is a modern statement of easy living and the feel good factor.



LINTELOO



HAMPTONS

2014 JAN TE LINTELO

The Hamptons sofa system is inspired by the easy going lifestyle of The Hamptons on Long Island, New York. The modular elements and ottomans can be combined into numerous arrangements. Available in both fabric and leather upholstery. The Hamptons cabinet (available separately) functions both as an armrest and a side table.

LINTELOO

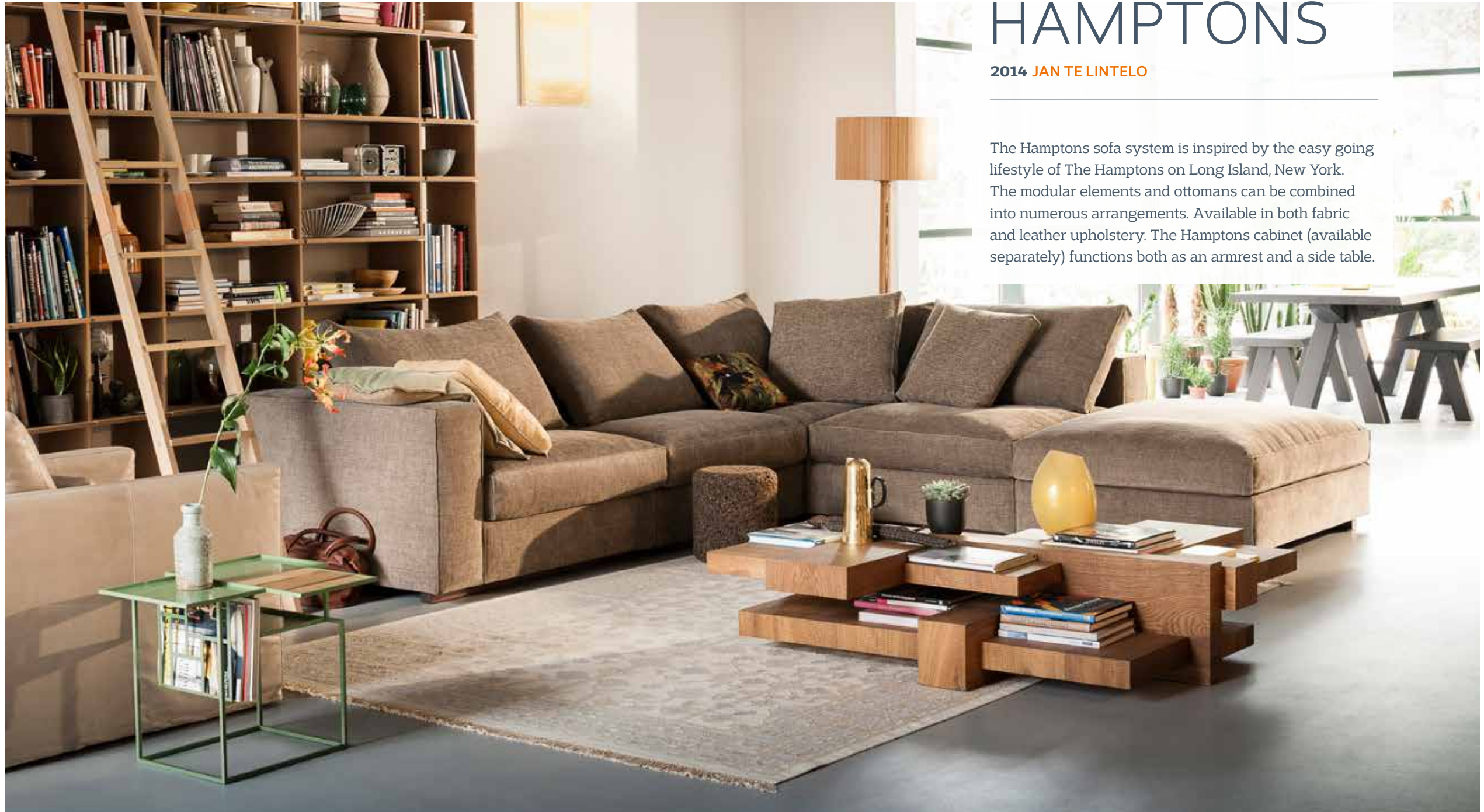

RECESS

2012 **NIELS BENDTSEN**

LINTELOO

Niels Bendtsen designed this elegant sofa system with a classic look and contemporary feel. Creating a distinct mood due to the sophisticated combination of fabrics and leather. The sofa has removable covers and the legs are in metal anthracite.



JAN'S NEW SOFA

2010 **PAOLA NAVONE**

Jan's New Sofa is based on elements that can be combined in many configurations. Designer Paola Navone created a comfortable sofa that easily changes the way it looks, by just changing the beautifully made soft linen removable covers. This sofa is a clear invitation to enjoy life: sitting, sleeping, talking, relaxing.

LINTELOO

SPECS
PAGE 112

PAOLA
NAVONE

LINTELOO

Graduated from Turin Polytechnic in 1973, Paola Navone has become well known for her designs for important international brands. She is also successful as an art director, interior decorator, industrial planner and creator of events. "This is the way I always work: I get inspiration and ideas from knowing and befriending people. I have a special connection with LINTELOO, a personal click with both Jan and Lars. You could almost call it a love affair. The love for food and cooking, along with travelling to other countries, turned out to be just some of the things we share."

45

SPECS
PAGE 112

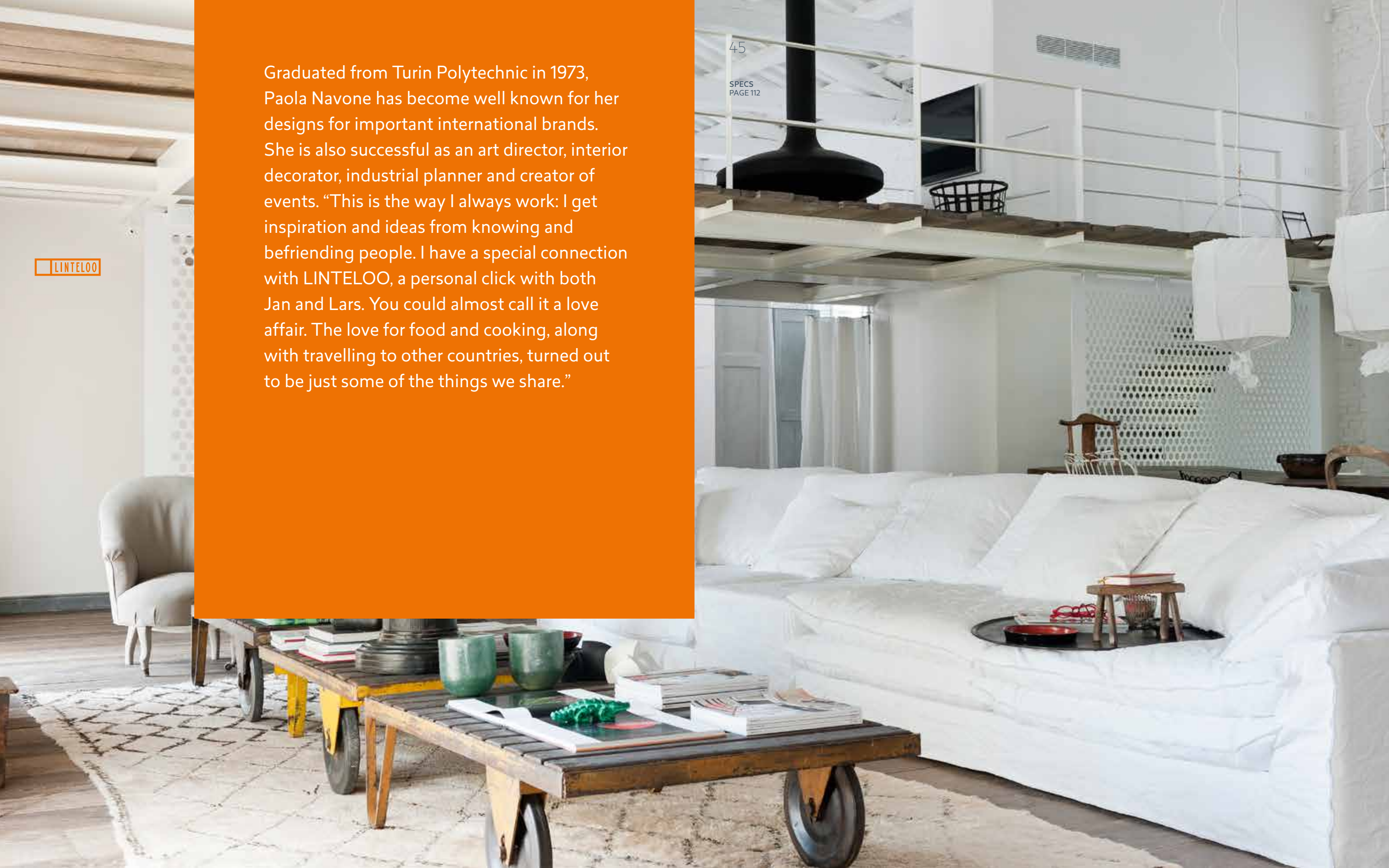

MARK

2016 SEBASTIAN HERKNER

LINTELOO

Mark is the result of the first collaboration between LINTELOO and Sebastian Herkner. The collection consists of a dining table and chair. The design of this collection is like a sign, a graphic silhouette, based on the use of solid wood and strong shapes. The structure of the chair with three legs adds comfort and elegance. Available in natural (solid) ash or various colours.



LINTELOO



FLORIAN LOUNGE

2018 SJOERD VROONLAND

The Florian Lounge Chair is produced using a singular mold and combines Sjoerd's knowledge and love of craft with the DNA of LINTELOO's comfortable living and enjoyment of life.





LINTELOO

ISOLA

2008 **RODERICK VOS**

Why should a table always be round, square or rectangular? Designer Roderick Vos was inspired by nature. To be precise: by the pattern waves leave on sandy beaches. The Isola table is tribute to this natural phenomenon. Made of solid oak with delicately milled rings, available in white wash or anthracite.

TULIPANI

2006 **RODERICK VOS**

LINTELOO

Tulipani is a bestseller from the very beginning. This design by Roderick Vos is a modern version of the traditional wooden farmer's kitchen chair. Made of plywood birch and American Walnut and available in natural walnut, Pure White or any other RAL colour on request. Now also available in an upholstered version.



RODERICK
VOS

LINTELOO

Dutch designer Roderick Vos (1965) graduated from the Design Academy Eindhoven in 1990. With his wife Claire, he ran a design and manufacturing company on the Indonesian island of Java. In 2004, they started their own design office and store in Den Bosch, in the South of the Netherlands. Roderick Vos has been designing for LINTELOO from the beginning, his unconstrained creativity is clearly appreciated by Jan te Linteloo. “LINTELOO furniture has a recognisable global identity. The brand is all about comfort and making our interiors more livable. In my work, I always follow my instinct, not interior trends. That’s something Jan and I definitely have in common. We focus on beauty.”



THE SICILIAN

2010 RODERICK VOS

Roderick Vos designed this striking and robust table, suitable for any big family. The indestructible steel base has a dark brown copper speckle structure with an almost 'floating' top of mixwood or solid French oak. Available in different sizes up to 380 cm.

LINTELOO





KIGI

2015 RODERICK VOS

LINTELOO

These side tables by Roderick Vos celebrate the art of wood turning. For LINTELOO he designed three round side tables in different sizes and heights named Kigi translated as family of trees. The side tables were strongly influenced by Japanese style and characterized by minimalism, clean lines and simple shapes.



LINTELOO

EASY LIVING

1994 JAN TE LINTELO

LINTELOO's first and all-time bestseller with a comfortable, timeless and lively design that invites to plump down. The sofa has double springs (pocketed and nosag), double upholstered cushions and loose covers. Available in both fabric and leather upholstery.





MARCEL
WOLTERINCK

LINTELOO

Marcel Wolterinck opened his shop in Laren (NL) in 1986. His unique creations with clear signature did not go unnoticed international. His goal is to aim for perfection and that resulted in, a healthy track-record of unique and special interiors, combined with his own furniture line, various books and CD editions. Meanwhile the Wolterinck brand consists of 3 very successful business units: Interior, Garden Architecture and Product Design. Marcel Wolterinck is inspired by nature; “The philosophy in all of my works is that outside and inside grow together towards each other. Overlapping and if possible whereby the lines of the garden design connect with the interior.” By finding a perfect balance between classic and modern and by using different materials, amazing effects can be achieved. “My goal is to create an atmosphere which is theatrical but understated yet elegant”, Marcel Wolterinck says.

CERVINO

2011 MARCEL WOLTERINCK

LINTELOO

The Cervino collection is characterized by rounded shapes. The seat, legs and backs of the chairs and sofa all have an elegant curve. The thin frame of the chairs seem to float. On the inside of the spine, the soft pads provide additional comfort. The outer side of the backrest on the other hand has a solid appearance, by the use of a different type of fabric.





LINTELOO

FIGILIO

2011 MARCEL WOLTERINCK

The sofa's of the Figilio series are on a sled, a beautiful frame that provides an elegant look. The sofa's themselves are richly filled with soft cushions resulting in a very comfortable seat. The cushions are contrasting nicely with the exterior of the sofa, made of high quality leather for a clean look.



LINTELOO

MANTOVA

2011 MARCEL WOLTERINCK

These luxury side tables and consoles have vertical and horizontal lines that are all symmetrical. The side tables are practical and matches to almost all sofa's. The consoles create the ultimate decor space to present your sculptures, glass, ceramics and other pieces of art or decoration.

LINTELOO



INSIDE OUT

2018 KLAAS KUIKEN

With Inside Out Cabinets, Klaas set out to reveal the beauty of the Medite Greenpanel material, often hidden within pieces and not shown outwardly. This inside-out take on the cabinet elevates the materials used to a central focus.



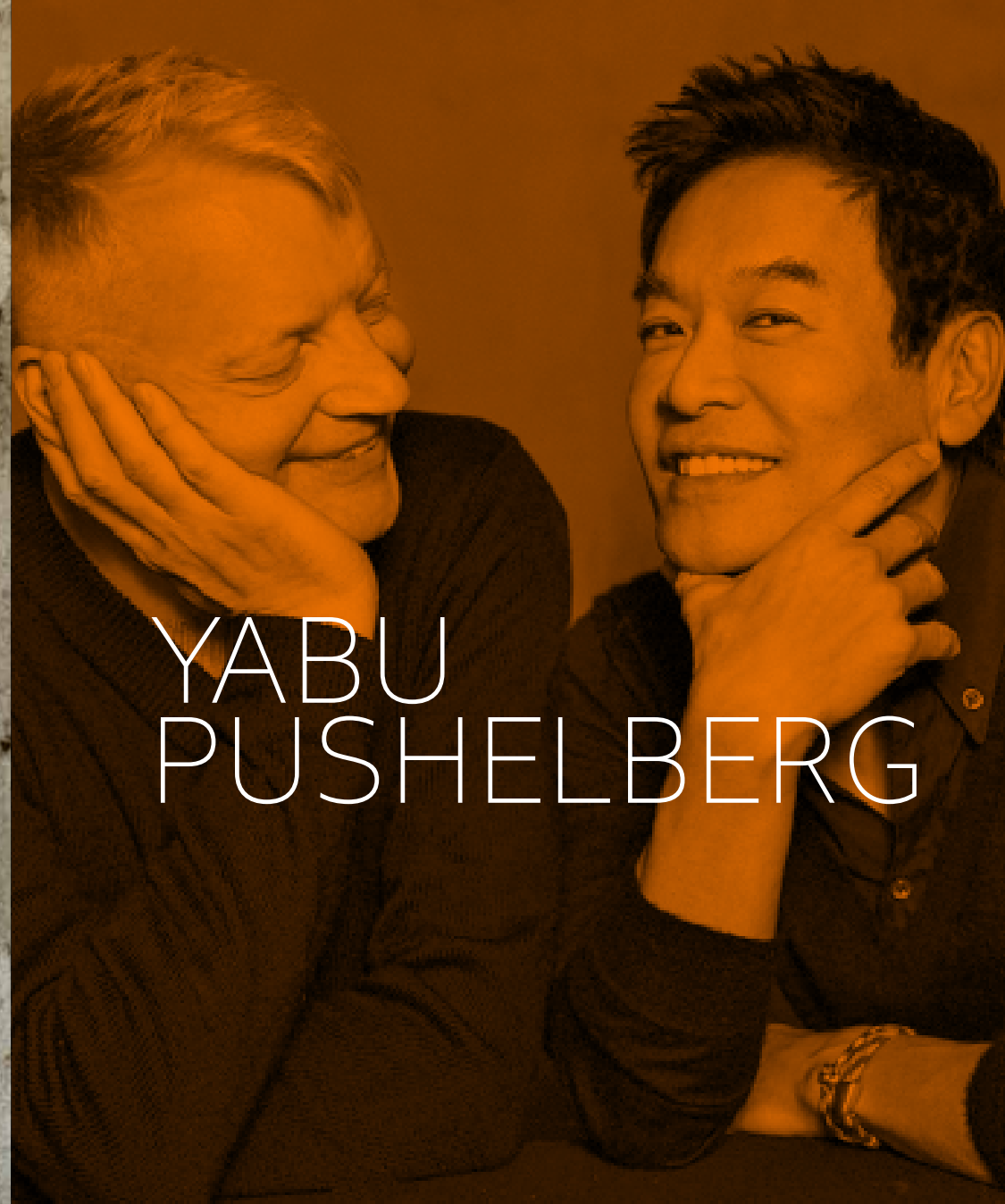

YABU
PUSHELBERG



Design firm Yabu Pushelberg, founded in 1980 by Ryerson University graduates George Yabu and Glenn Pushelberg, is now one of the most recognized design firms worldwide with studios in Toronto and New York and projects in over 16 countries. The firm's multidisciplinary approach is inspired by an endless curiosity and driven by partnerships with thoughtful, creative, like-minded people. Embracing all aspects of design, each new venture reflects a refined approach that is imaginative, thoughtful and honest; continuously shifting between the rational and the intuitive.



LINTELOO

OISEAU DINING CHAIR

2016 YABU PUSHELBERG

The Oiseau dining chair, also available as lounge chair, is part of the Oiseau collection designed by Yabu Pushelberg. Inviting, relaxed proportions lend themselves to an intimate living experience. The chairs with webbed upholstered seats afford a setting where dinners comfortably linger long past the end of the meal. The earthy color palette of dark moss, stone and flax enrich the restrained, hand-crafted quality of this collection.

OISEAU DINING BENCH

2016 YABU PUSHELBERG

LINTELOO





OISEAU DINING TABLE

LINTELOO

2016 YABU PUSHELBERG

This dining table is part of the Oiseau collection designed by Yabu Pushelberg. Inviting and relaxed proportions lend themselves to an intimate dining experience. The earthy colour palette of dark moss, stone and flax enrich the restrained, handcrafted quality of this collection of wood-frame chairs and tables.





LINTELOO

HEATH SOFA & ARMCHAIR

2016 YABU PUSHELBERG

The Heath sofa and armchair are part of the Heath collection; a group of tailored, curvilinear upholstered pieces made up of complex curves and directions. Both the sofa and armchair, designed by Canadian design firm Yabu Pushelberg, includes multiple configurations and the deep seating is precisely molded to embrace the body.

LINTELOO



HEATH COFFEE TABLE

2016 YABU PUSHELBERG

The amorphous stone-topped Heath coffee table is a group of tailored, curvilinear upholstered pieces made up of complex curves and directions. Creating a perceived lightness the zebrino marble table, available in 2 different sizes, is set atop turned wood legs in olive green, charcoal grey or cream white.



RELAX

2016 JAN DES BOUVRIE

Timeless, stylish and great comfort are the hallmarks of this Relax creation. The Relax is designed by celebrated Dutch designer Jan des Bouvrie, known for his use of sleek lines and clear shapes. Available in both fabric and leather upholstery, the frame is available in matt chrome, bronze and graphite grey.

LINTELOO



SOUTHAMPTON

2015 JAN TE LINTELO

LINTELOO

The Southampton is inviting, compact, and made for hours of relaxation. This sofa is a casual version of Jan te Lintelo's Hamptons seating system. With a variety of different elements it is possible to create your own feel-good arrangement. The sofa is available in both fabric and leather upholstery.



FABIO

2004 JAN TE LINTELO

This sofa consists of a spacious and relaxed modular seating system as a result of a large choice of elements in different sizes. Fabio will find and create a home anywhere. Available in both fabric and leather upholstery.

LINTELOO





KONE

1994 ANDERS NØRGAARD

LINTELOO

The Kone armchair has a beautiful Scandinavian appearance where comfort and functionality are carefully combined. The elegant effect is most noticeable when you admire the chair from the side. The armchair is available with a high or a low back and upholstered in both fabric and leather.



METROPOLITAN

2016 JAN TE LINTELO

LINTELOO

The timeless design with contemporary details ensuring maximum comfort and endless possibilities. The sofa comes in different sizes and depths. Available in both fabric and leather upholstery. The sofa's legs offer different options, angles and positions, guaranteeing the perfect fit.





SPECS

LINTELOO COLLECTION

LINTELOO



INDEX

LINTELOO COLLECTION

LINTELOO

Alto _____	92	Florian _____	102	Mauro _____	118
Ample _____	92	Gent _____	102	Metropolitan _____	120
Andy _____	92	George _____	103	Miles _____	122
Arp _____	92	Giulietta _____	104	Model D _____	123
Aulia _____	93	Glow cushions _____	104	Moreno _____	123
Azzano _____	93	Hamptons _____	105	Njoy XL _____	124
Balanced _____	93	Heath _____	108	Nureyev _____	126
Blush rug _____	93	Highline _____	109	Obi _____	126
Boogie Woogie _____	93	Inside out _____	111	Oiseau _____	126
Cervino _____	94	Ishi _____	111	Pavia _____	128
Converse _____	95	Isola _____	111	Pleasure _____	128
Cubo _____	95	Jan's New Sofa _____	112	Recess _____	130
Cup of Tea _____	95	Kigi _____	114	Relax _____	131
Dario _____	96	Kone _____	114	the Sicilian _____	132
Dario outdoor _____	96	Log _____	114	Southampton _____	133
Desire _____	97	Lowtide _____	115	Terrace _____	135
DWI _____	98	Madison _____	115	Tulipani _____	135
Easy Living _____	98	Manhattan _____	117	Vanity _____	135
Fabio _____	100	Mantova _____	117	VNU _____	136
Figilio _____	102	Mark _____	117		



ALTO LIGHT

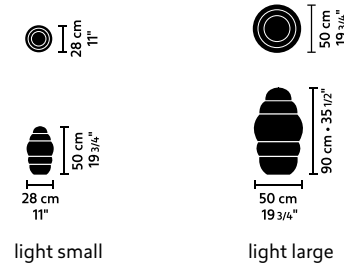

light small light large

AMPLE ARMCHAIR

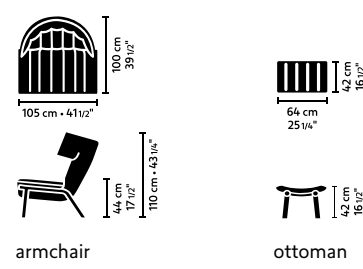

armchair ottoman

ANDY SOFA

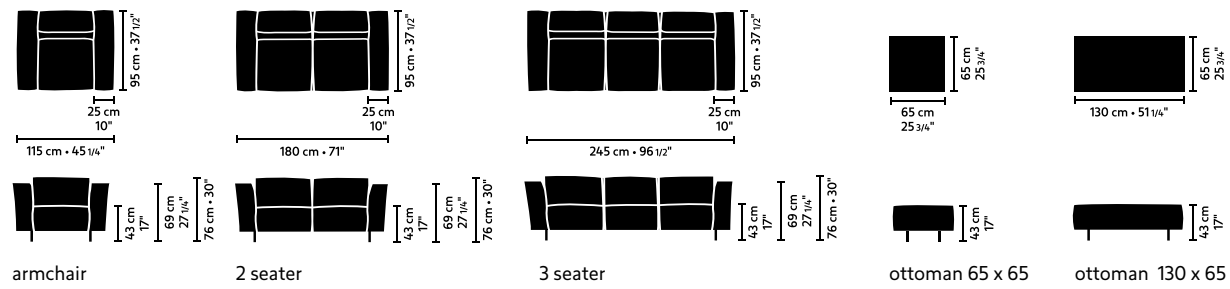

armchair 2 seater 3 seater ottoman 65 x 65 ottoman 130 x 65

ARP SOFA

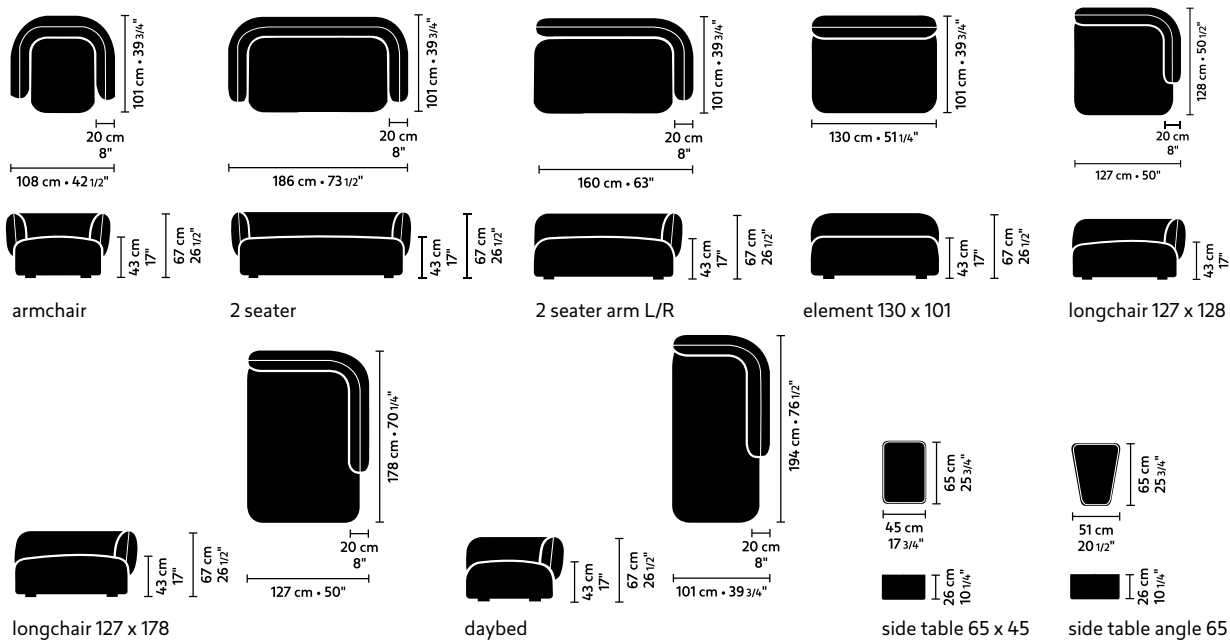

longchair 127 x 178 daybed side table 65 x 45 side table angle 65 x 51

AULIA COFFEE TABLE

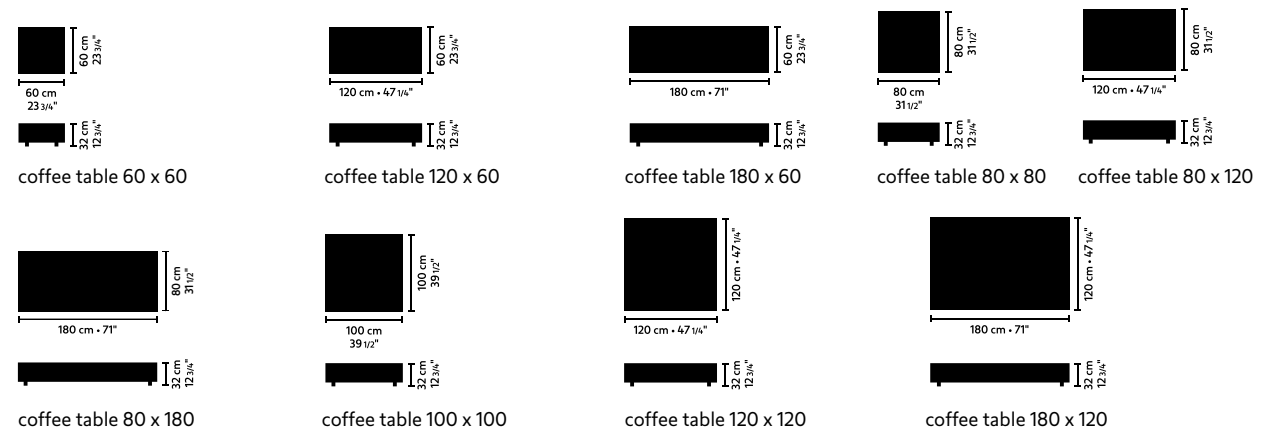

AZZANO ARMCHAIR

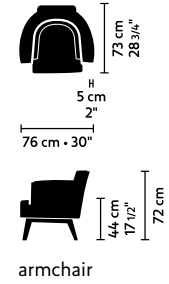

armchair

BALANCED SIDE TABLE

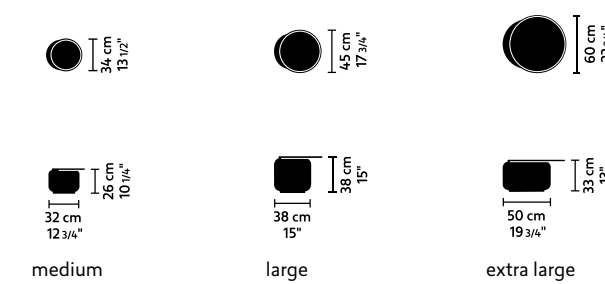

medium large extra large

BLUSH RUG

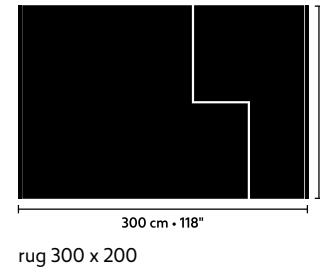

rug 300 x 200

BOOGIE WOOGIE SIDE TABLE

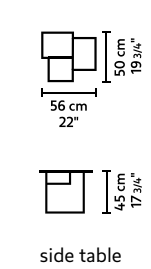

side table

CERVINO

ARMCHAIR

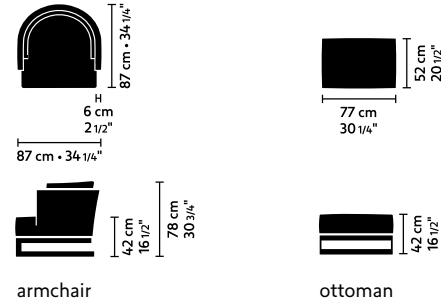

CERVINO

DINING CHAIR

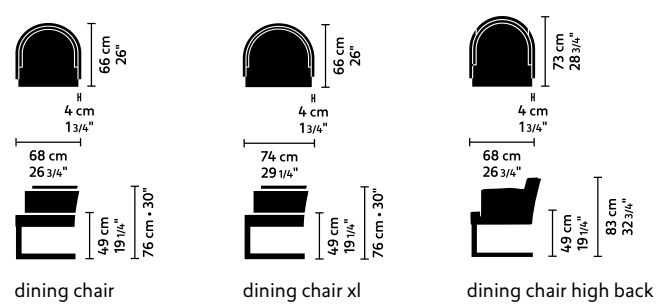

CERVINO

DINING TABLE

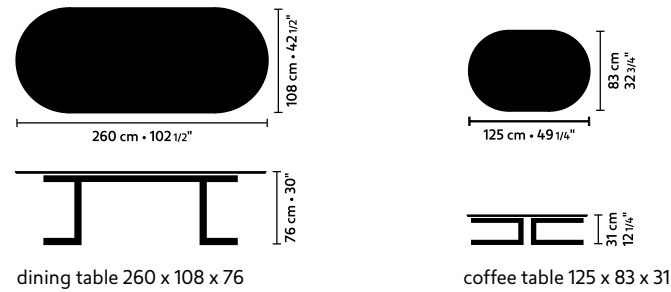

CERVINO

SOFA

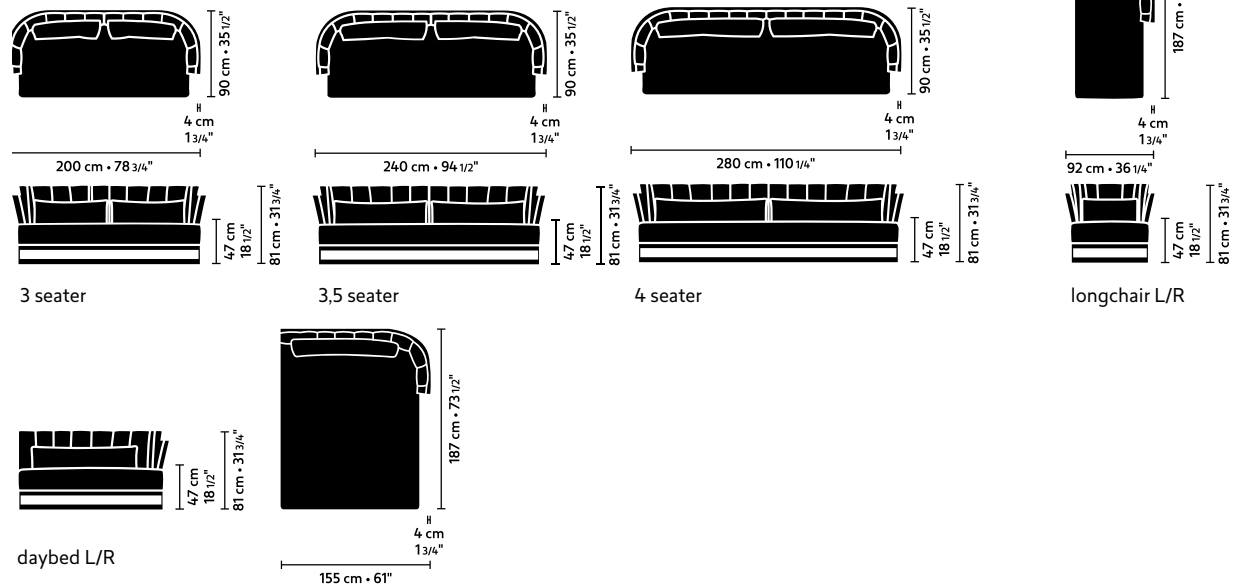

CONVERSE

DINING TABLE

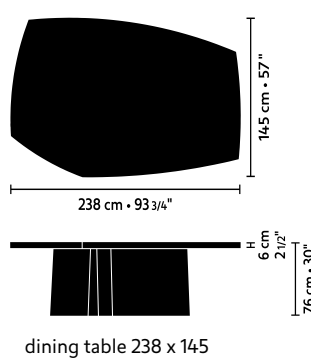

CUBO

LIGHT

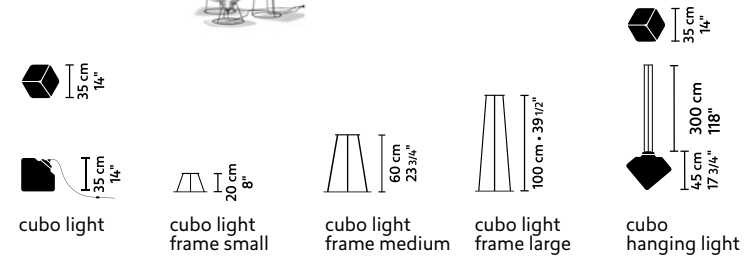

CUP OF TEA

SIDE TABLE

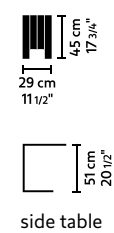

DARIO



ARMCHAIR

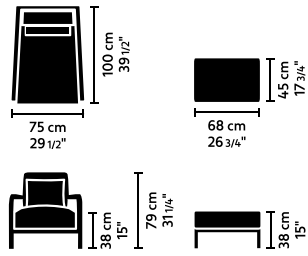

armchair

ottoman

DARIO

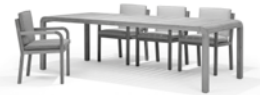

OUTDOOR

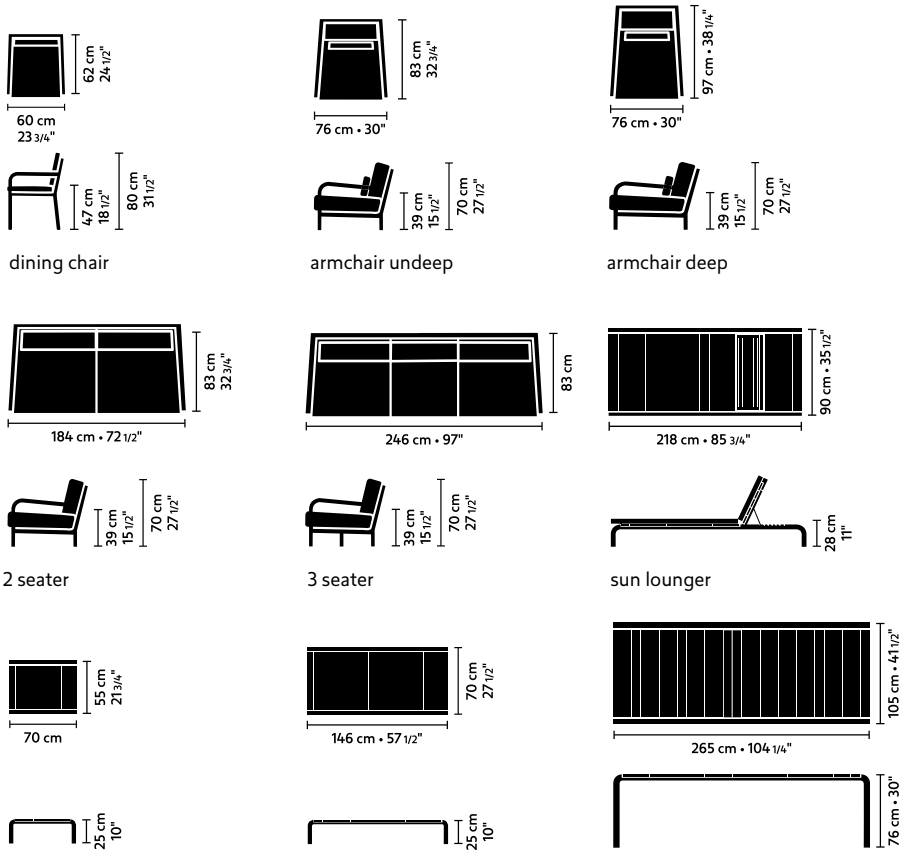

dining chair

armchair undeeep

armchair deep

2 seater

3 seater

sun lounger

side table 70 x 55 x 25

coffee table 145,5 x 70 x 25

dining table 266 x 105 x 76

DESIRE



SOFA

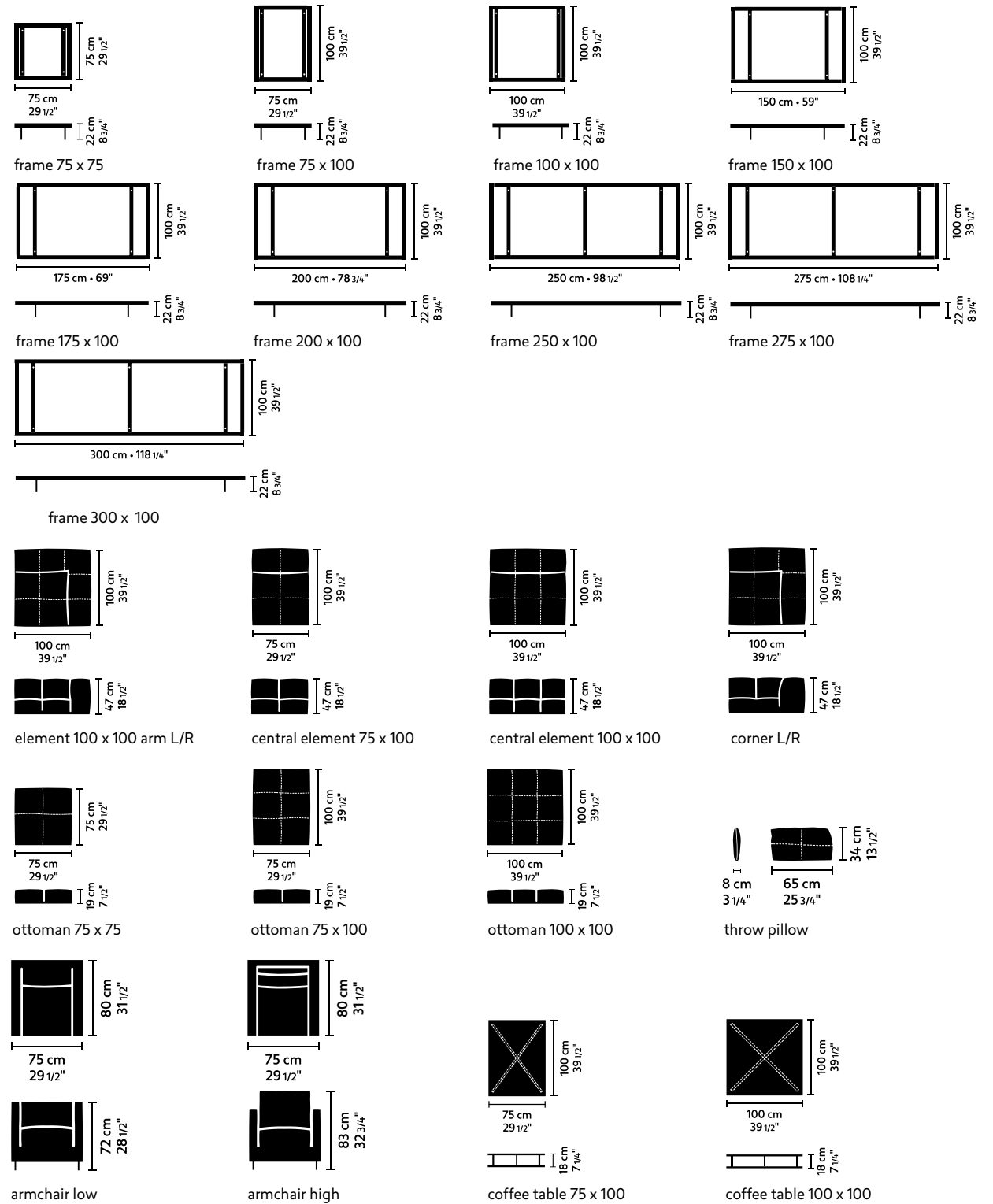

frame 75 x 75

frame 75 x 100

frame 100 x 100

frame 150 x 100

frame 175 x 100

frame 200 x 100

frame 250 x 100

frame 275 x 100

frame 300 x 100

element 100 x 100 arm L/R

central element 75 x 100

central element 100 x 100

corner L/R

ottoman 75 x 75

ottoman 75 x 100

ottoman 100 x 100

throw pillow

armchair low

armchair high

coffee table 75 x 100

coffee table 100 x 100

DWI

DINING CHAIR



dining chair 44 x 70

dining chair 51 x 70

dining chair 66 x 70

dining bench

EASY LIVING



SOFA

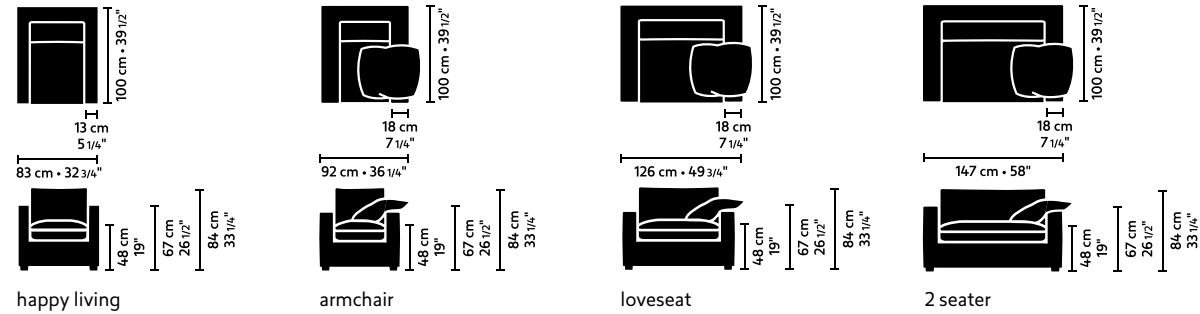

happy living

armchair

loveseat

2 seater

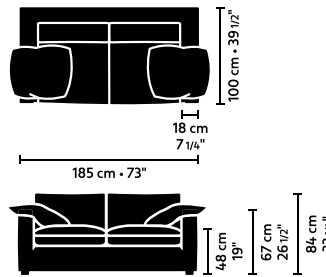

2,5 seater

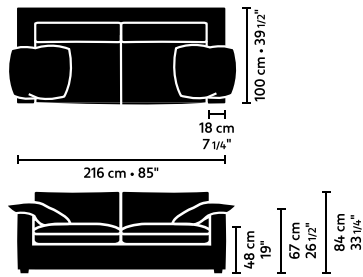

3 seater

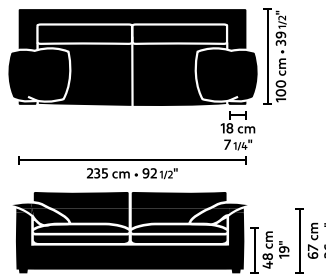

3,5 seater

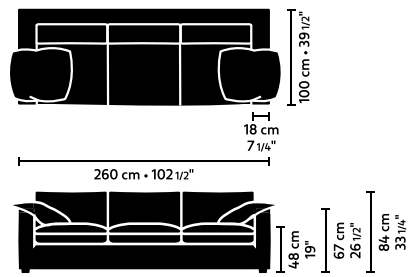

4 seater

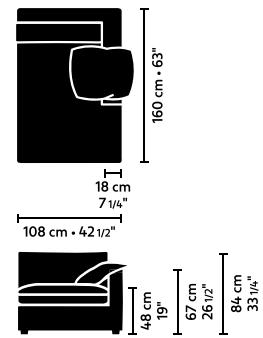

longchair arm L/R

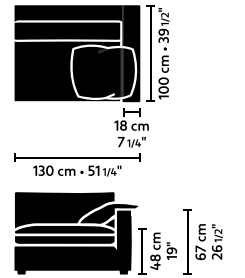

element 130 x 100 arm L/R

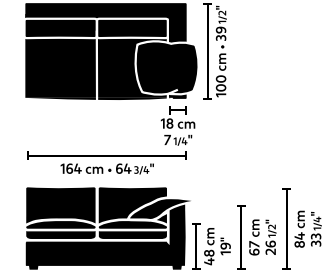

element 164 x 100 arm L/R

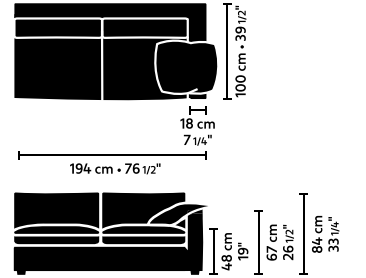

element 194 x 100 arm L/R



central element 110 x 100



central element 150 x 100

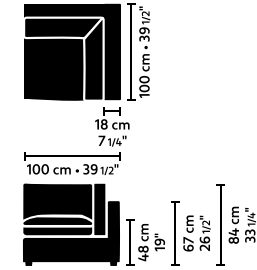

corner L/R

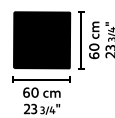

ottoman 60 x 60

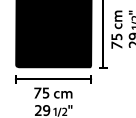

ottoman 75 x 75

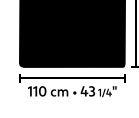

ottoman 110 x 110



arm pillow

FABIO

SOFA

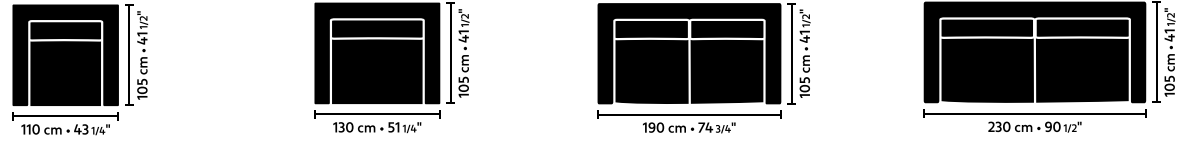

armchair loveseat 2,5 seater 3 seater

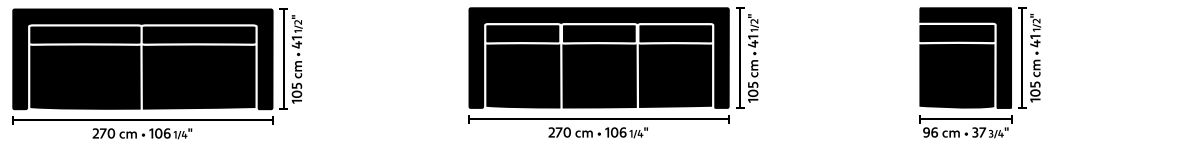

4 seater - 2 cushions 4 seater - 3 cushions element 96 x 106 arm L/R

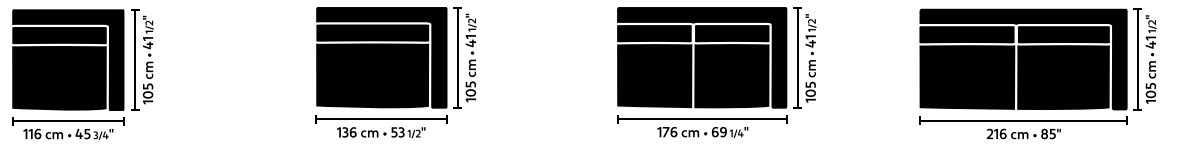

element 116 x 105 arm L/R element 136 x 105 arm L/R element 176 x 105 arm L/R element 216 x 105 arm L/R

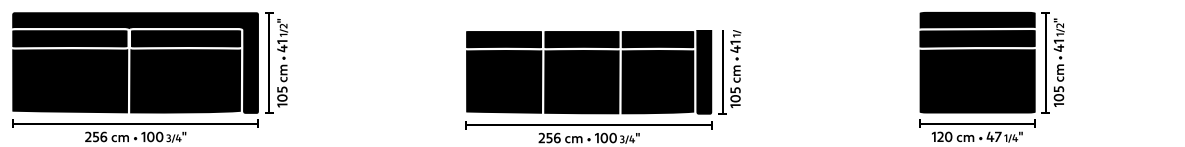

element 256 x 105 arm L/R - 2 cushions element 256 x 105 arm L/R - 3 cushions central element 120 x 105

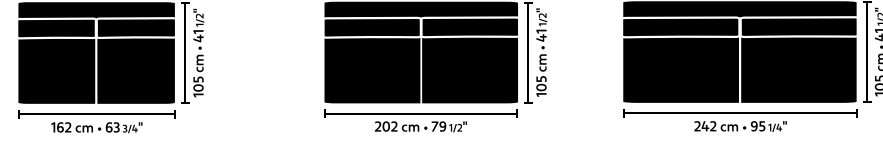

central element 162 x 105 central element 202 x 105 central element 242 x 105

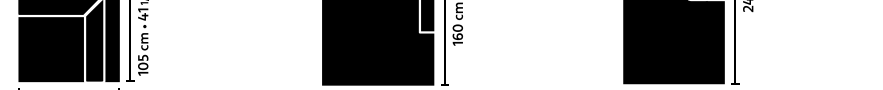
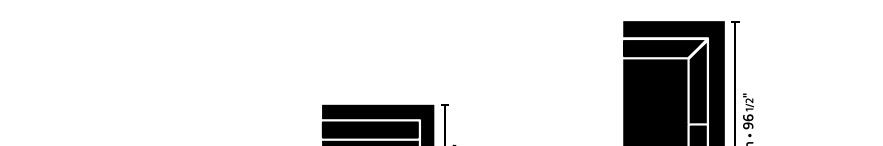

corner longchair arm L/R dormeuse arm L/R

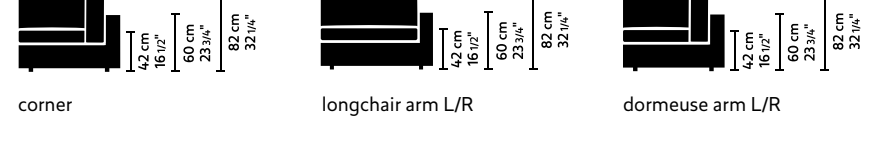

ottoman 80 x 80 ottoman 100 x 80 ottoman 120 x 80 ottoman 105 x 105



arm pillow drop pillow

FIGILIO

SOFA

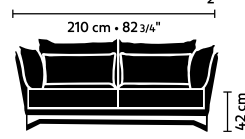

3 seater

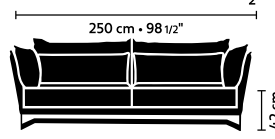
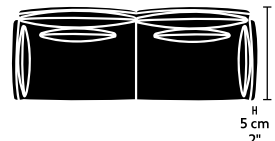

3,5 seater

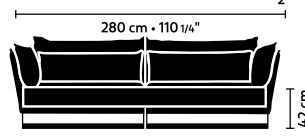
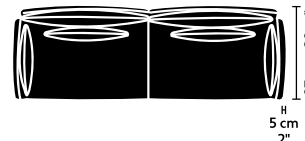

4 seater

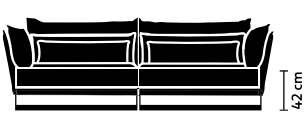
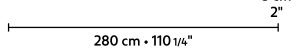
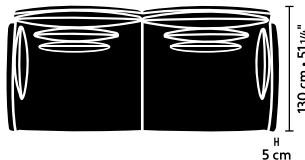

4 seater xl

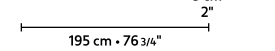
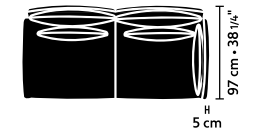

3 seater 1 arm L/R

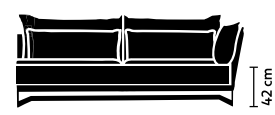
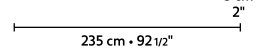
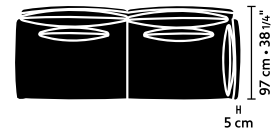

3,5 seater 1 arm L/R

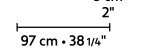
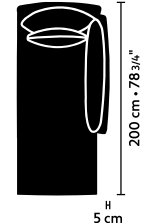

chaise longue

FLORIAN

ARMCHAIR

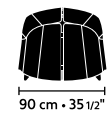

low back

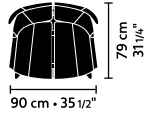

high back

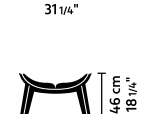
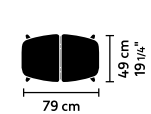

ottoman

GENT

DINING CHAIR

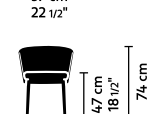
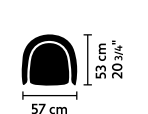

dining chair

GEORGE

SOFA

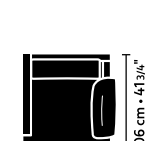

armchair

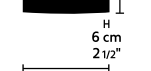
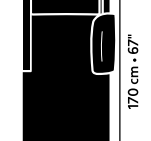

lounge chair

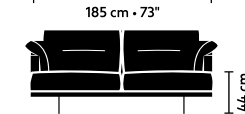
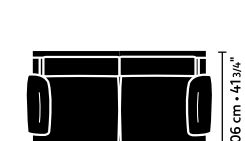

2 seater

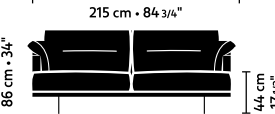

3 seater

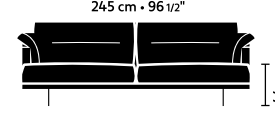
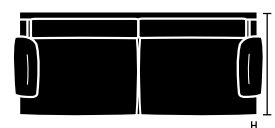

3,5 seater

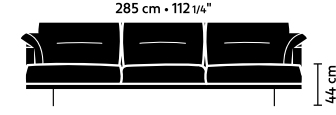
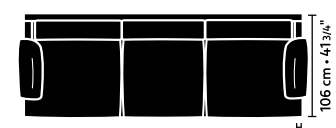

4 seater

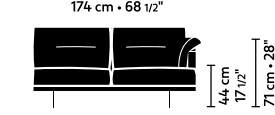
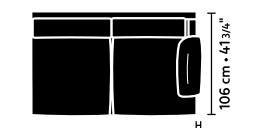

2 seater arm L/R

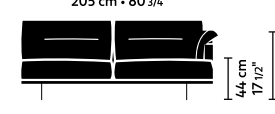
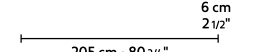
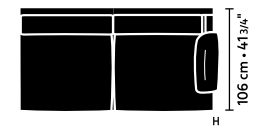

2,5 seater arm L/R

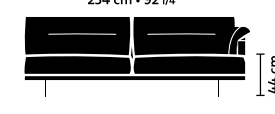
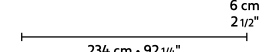

3 seater arm L/R

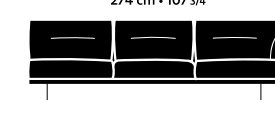
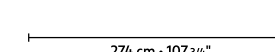
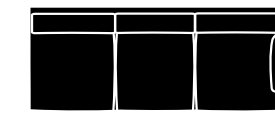

4 seater arm L/R

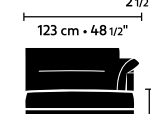
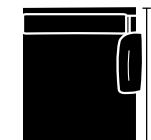

longchair arm L/R

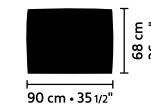

ottoman

GIULIETTA

DINING CHAIR

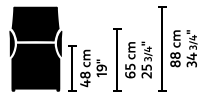
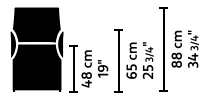
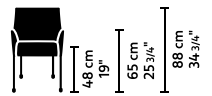
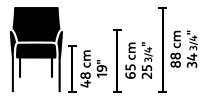
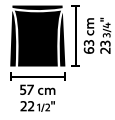
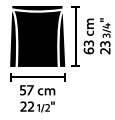
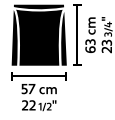
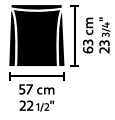

dining chair short cover

dining chair short cover on wheels

dining chair long cover

dining chair long cover on wheels

GLOW

CUSHIONS

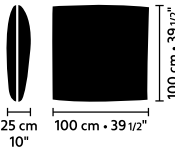
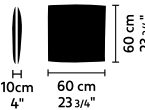
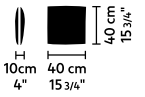
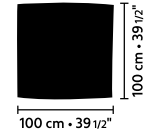
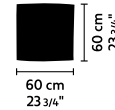

glow cushion 40 x 40

glow cushion 60 x 60

glow cushion 100 x 100

glow cushion set

HAMPTONS

SOFA

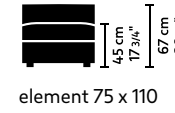
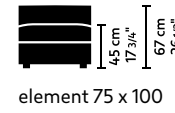
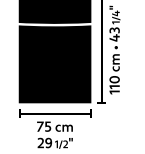
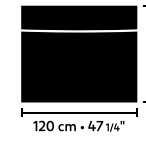
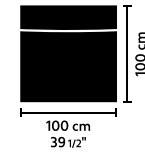

element 75 x 100

element 100 x 100

element 120 x 100

element 75 x 110

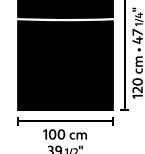
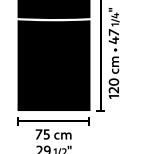
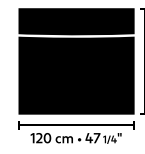
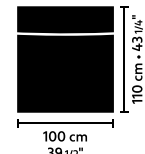

element 100 x 110

element 120 x 110

element 75 x 120

element 100 x 120

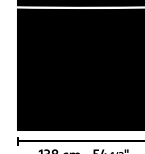
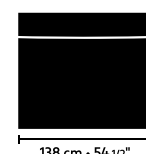
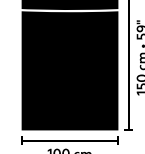
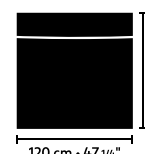

element 120 x 120

element 100 x 150

element 138 x 120

element 138 x 155

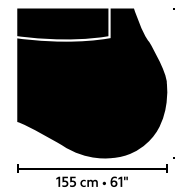

element round

arm low 25 x 100 L/R

arm high 25 x 100 L/R

arm low 41 x 100 L/R

arm high 41 x 100 L/R

arm low 25 x 110 L/R

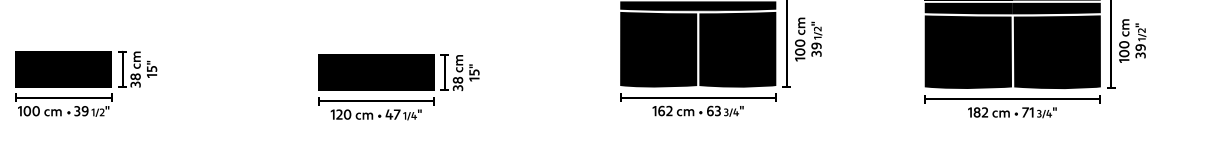
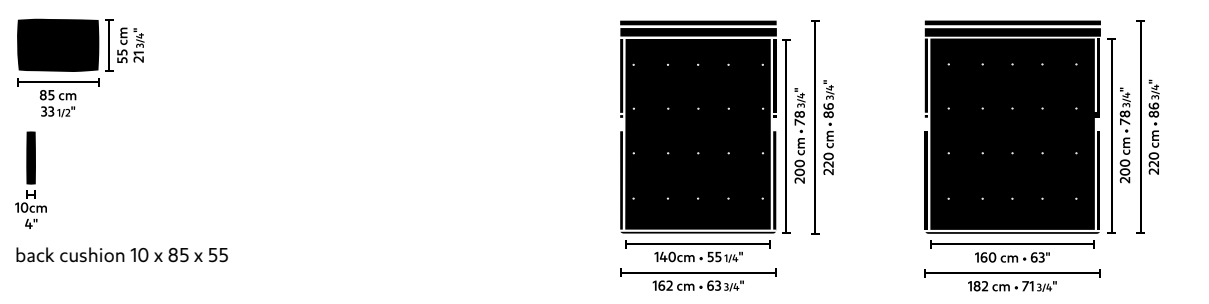
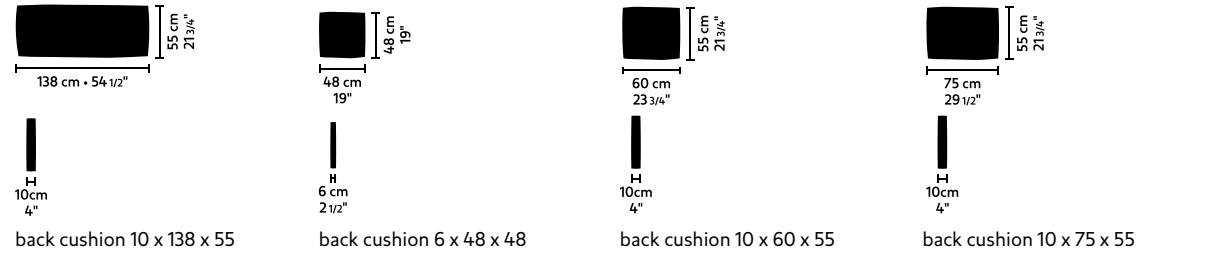
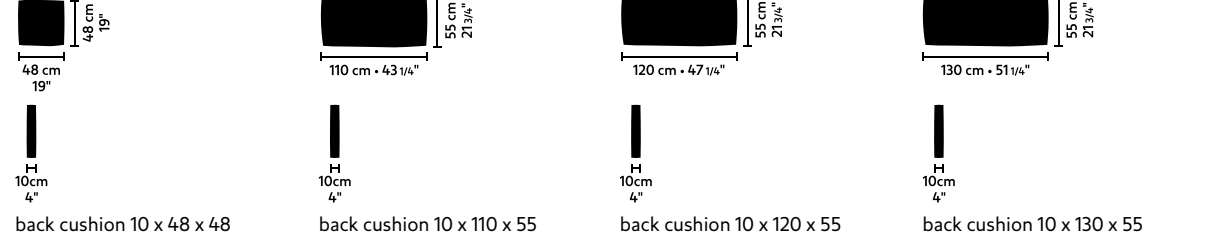
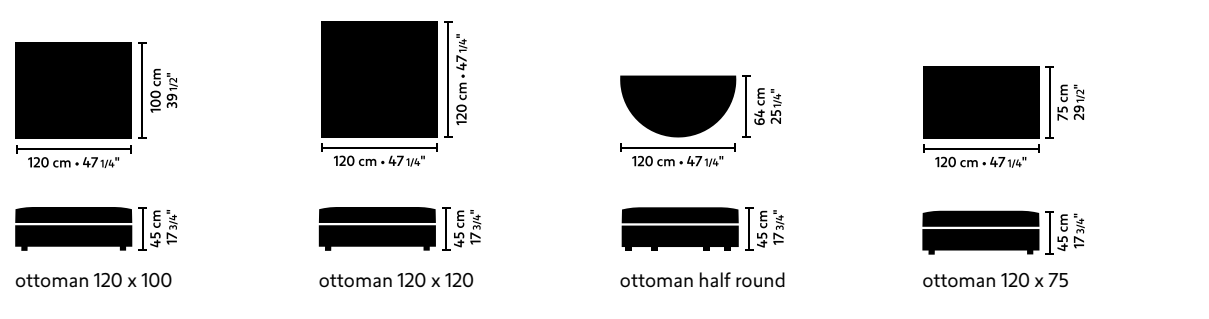
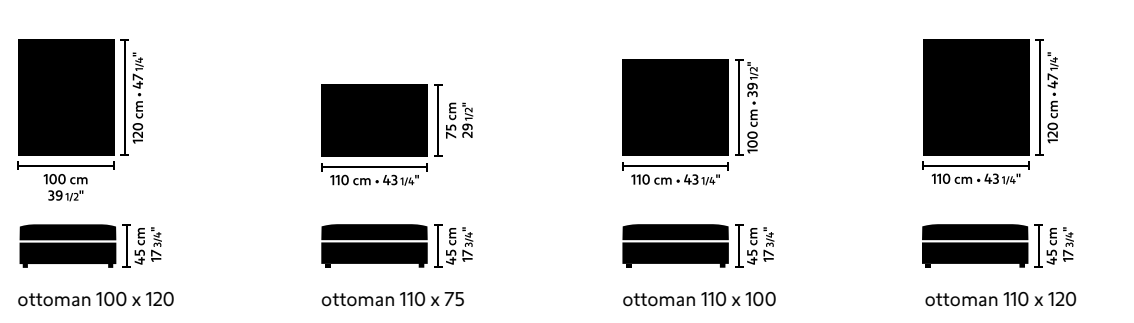
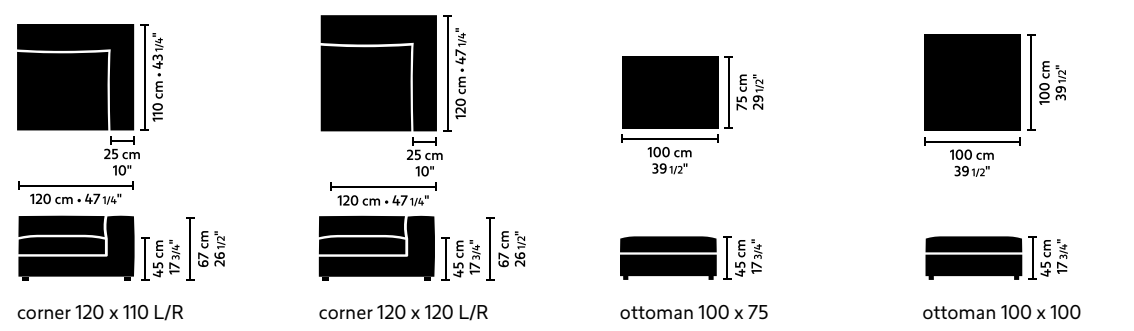
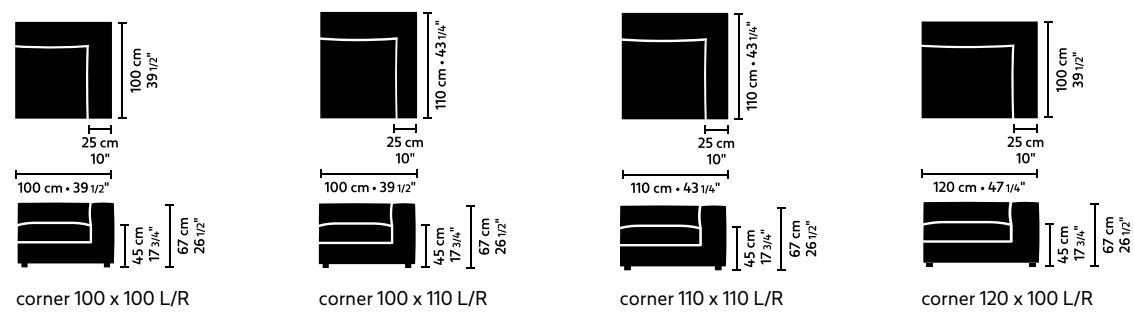
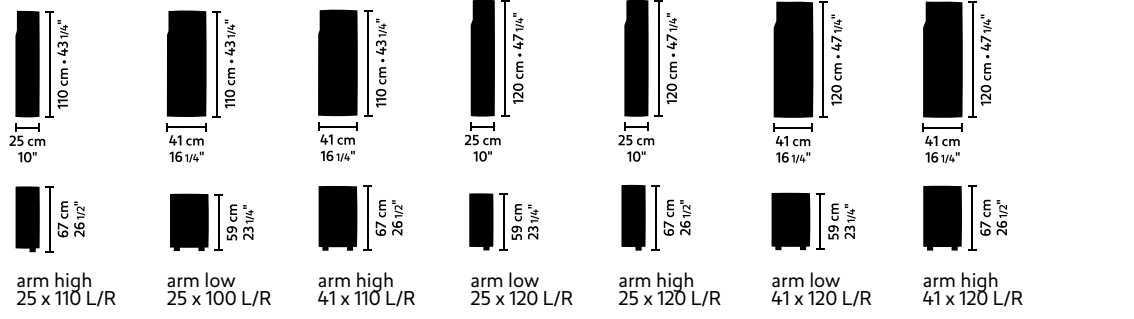

HEATH

ARMCHAIR

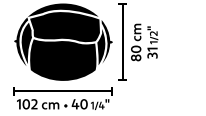
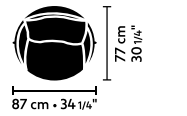

armchair 87 x 77

armchair 102 x 80

HEATH

COFFEE TABLE

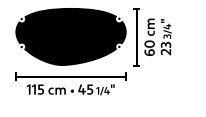
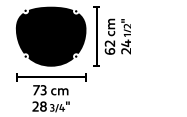

coffee table 73 x 62

coffee table 115 x 60

HEATH

SOFA

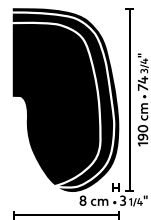
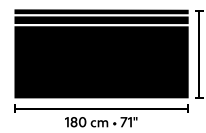
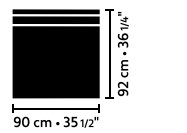

central element 90 x 92

central element 180 x 92

element 200 x 92

longchair arm L/R

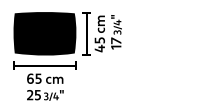
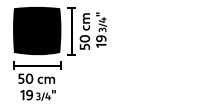
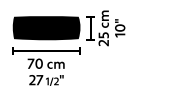

throw pillow 70 x 25

throw pillow 50 x 50

throw pillow 65 x 45

throw pillow 75 x 48

HIGHLINE

SOFA

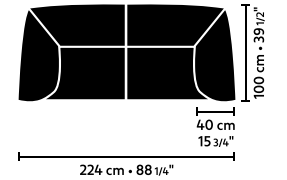
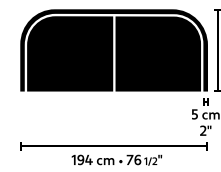
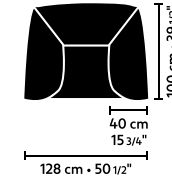
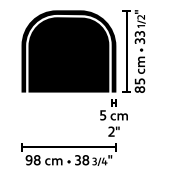

naked armchair undeeep

armchair undeeep

naked 2,5 seater undeeep

2,5 seater undeeep

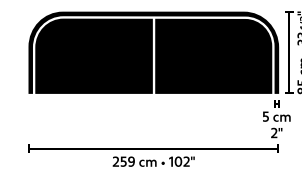
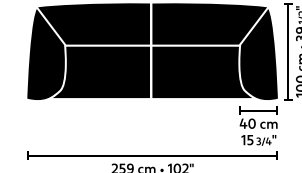
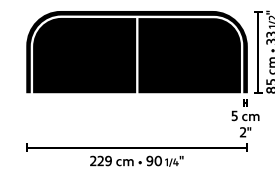

naked 3 seater undeeep

3 seater undeeep

naked 4 seater undeeep

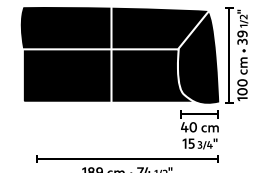
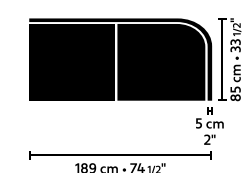
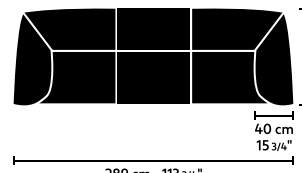

4 seater undeeep

naked 2,5 seater undeeep arm L/R

2,5 seater undeeep arm L/R

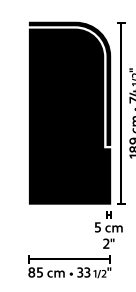

naked longchair undeeep arm L/R

longchair undeeep arm L/R

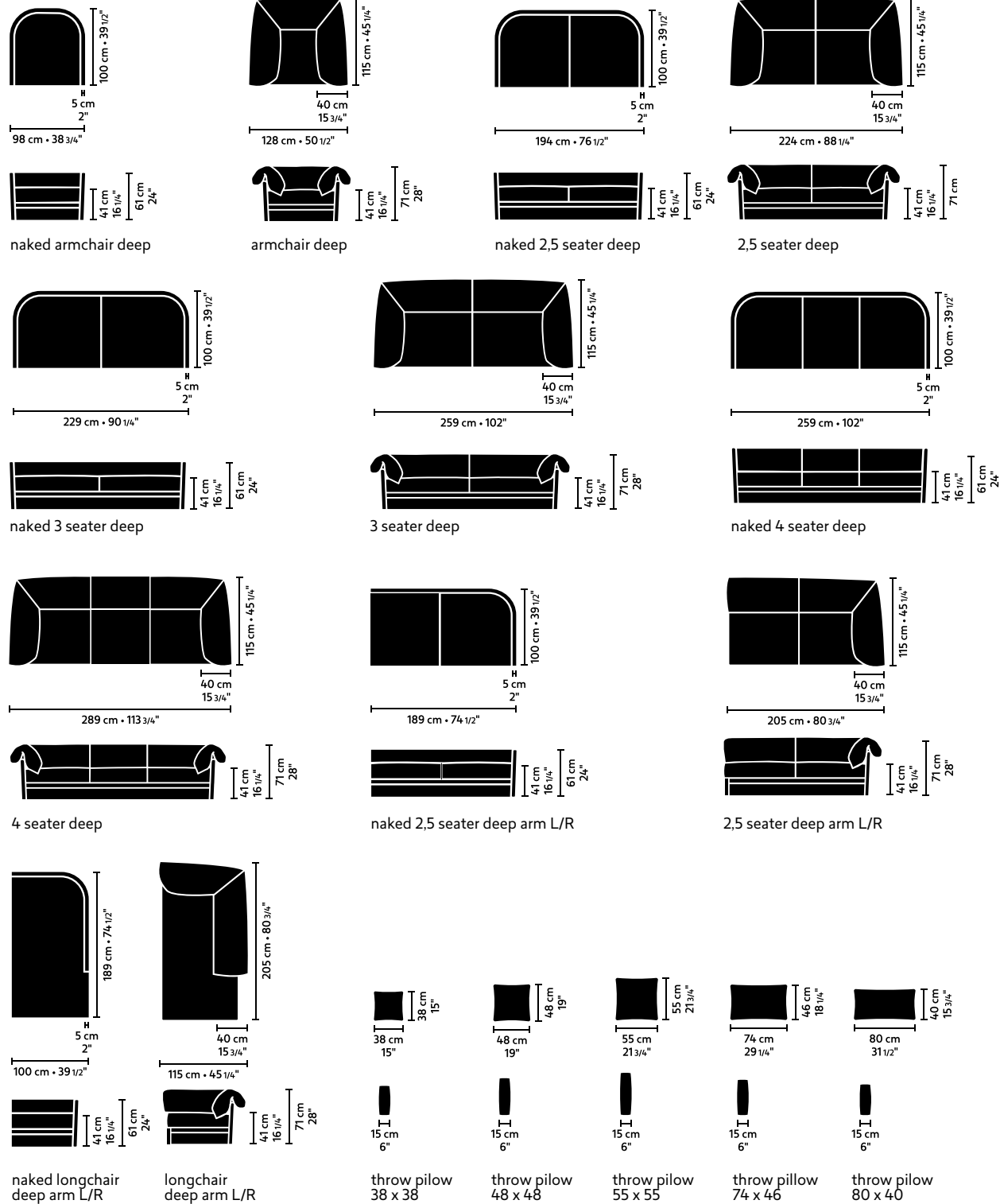

INSIDE OUT

CABINET

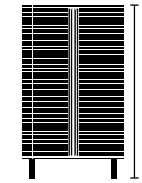
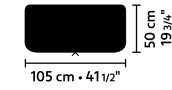

cabinet

ISHI

DINING TABLE

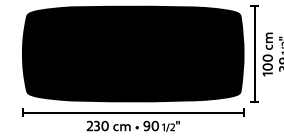

dining table 230 x 100

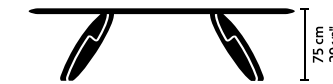
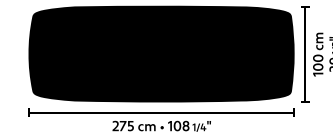

dining table 275 x 100

ISOLA

TABLE

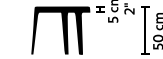
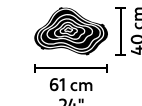

sidetable 61 x 40

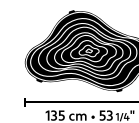

coffee table 135 x 85



coffee table 173 x 107

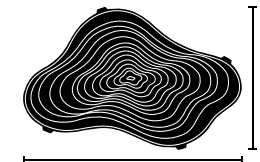

coffee table 226 x 148

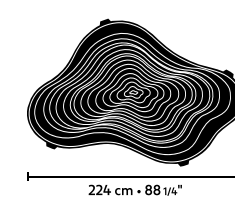

dining table 224 x 153

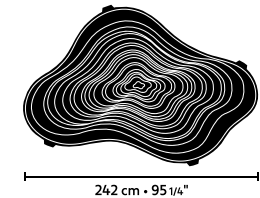

dining table 242 x 166

JAN'S NEW SOFA



SOFA

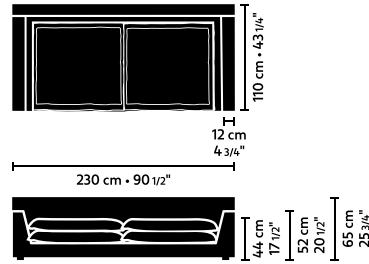

3 seater low undeeep + throw pillow set 2

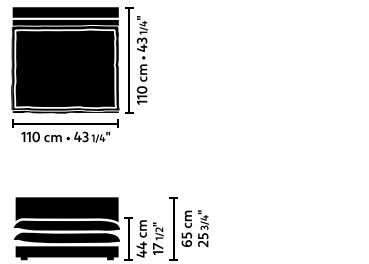

central element low 110 x 110 + throw pillow set 1

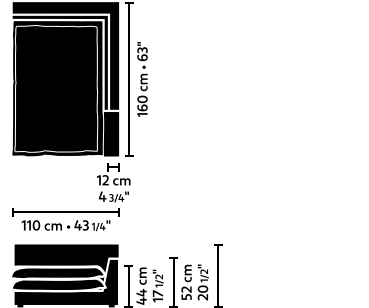

longchair low 110 x 160 arm L/R + throw pillow set 1

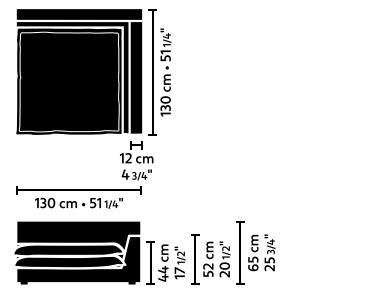

element low 130 x 130 arm L/R + throw pillow set 1

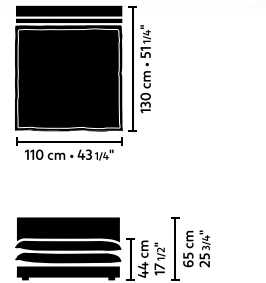

element low 130 x 110 arm L/R + throw pillow set 1

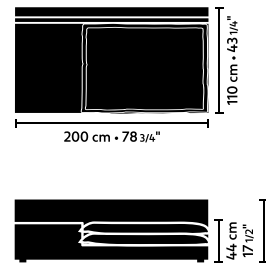

element low 200 x 110 with ottoman L/R + throw pillow set 1

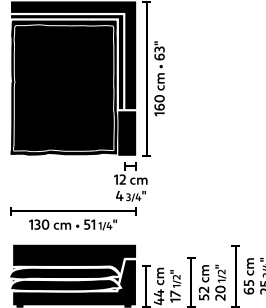

longchair low 130 x 160 arm L/R + throw pillow set 1

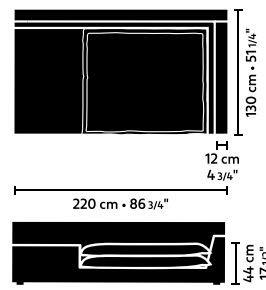

element low 220 x 130 with ottoman arm L/R + throw pillow set 1

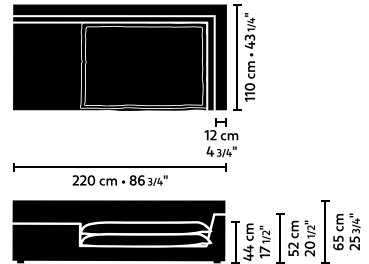

element low 220 x 110 with ottoman arm L/R + throw pillow set 1

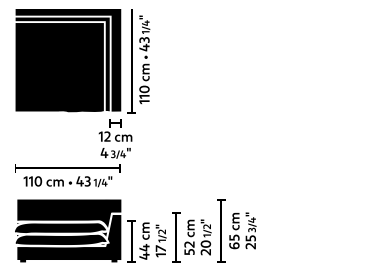

corner low 110 x 110 L/R + throw pillow set 1

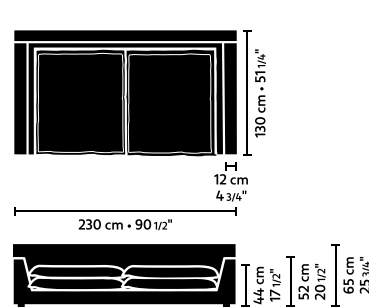

3 seater low deep + throw pillow set 2

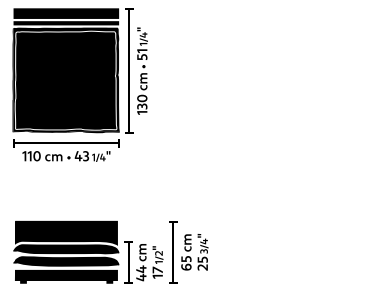

central element low 110 x 130 + throw pillow set 1

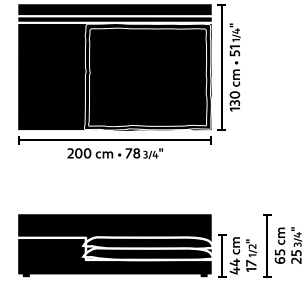

element low 200 x 130 with ottoman L/R + throw pillow set 1

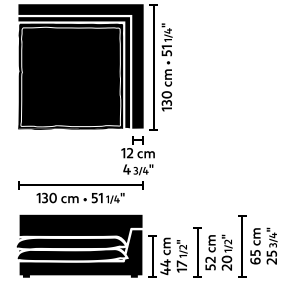

corner low 130 x 130 L/R + throw pillow set 1

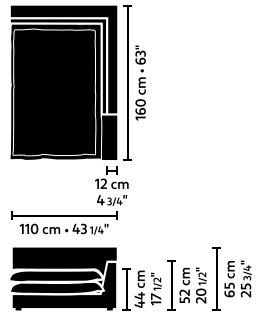

longchair low 110 x 160 arm L/R + throw pillow set 1

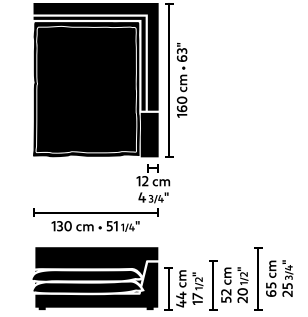

longchair low 130 x 160 arm L/R + throw pillow set 1

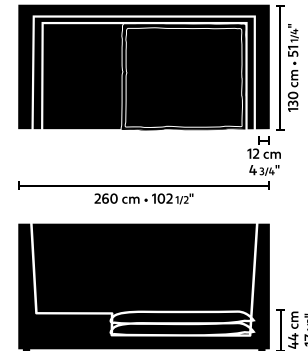

2 seater high deep with ottoman + throw pillow set 1

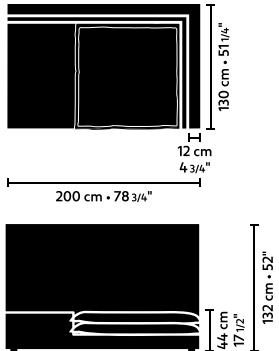

element high 200 x 130 with ottoman arm L/R + throw pillow set 1

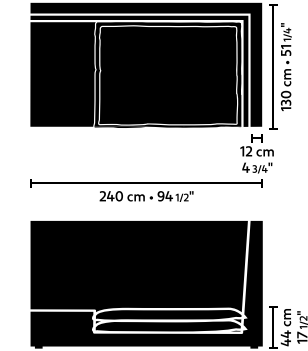

element high 240 x 130 with ottoman arm L/R + throw pillow set 1

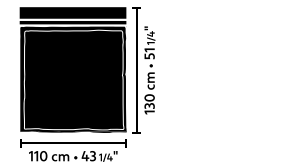

ottoman 110 x 70

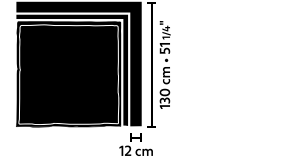

ottoman 130 x 70

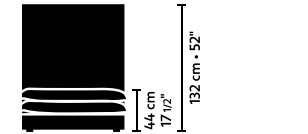

central element high 110 x 130 + throw pillow set 1

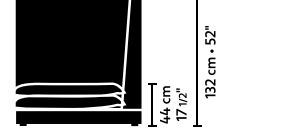

corner high 130 x 130 L/R + throw pillow set 1

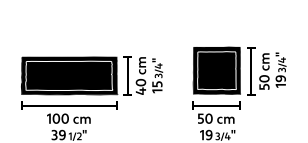

throw pillow 100 x 40

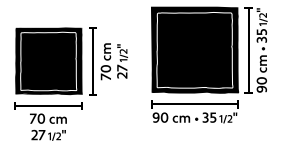

throw pillow 50 x 50

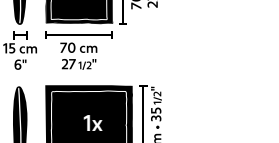

throw pillow 70 x 70

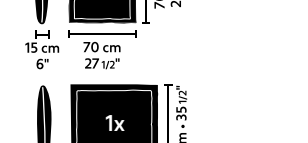

throw pillow 90 x 90

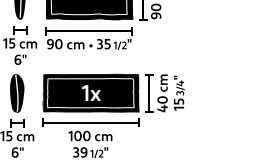

set 1

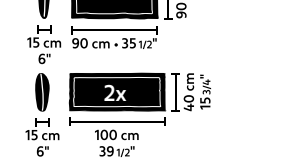

set 2

KIGI

SIDE TABLE

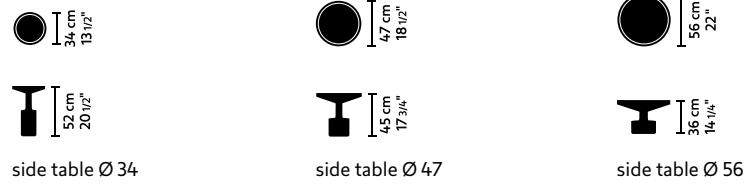

KONE

ARMCHAIR

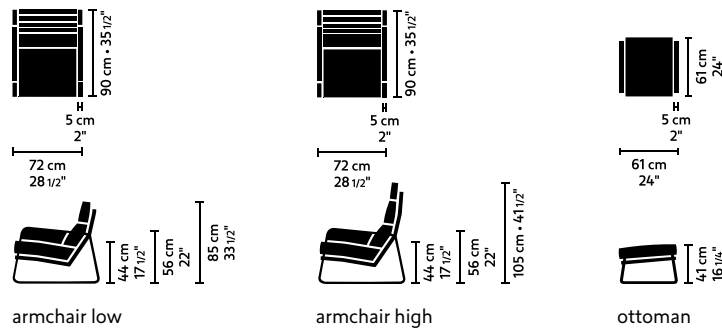

LOG

COFFEE TABLE & SIDE TABLE

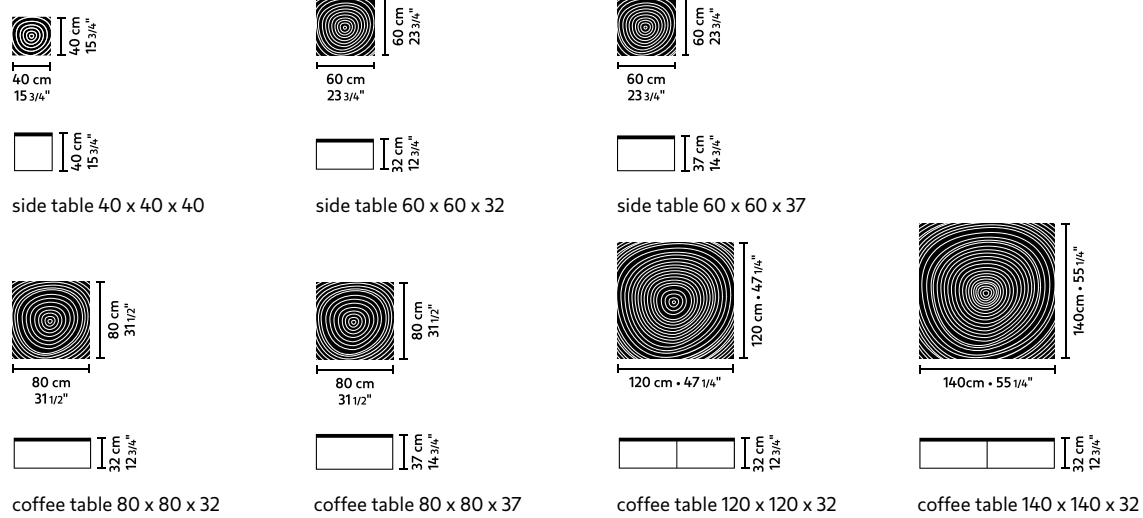

LOWTIDE

COFFEE TABLE

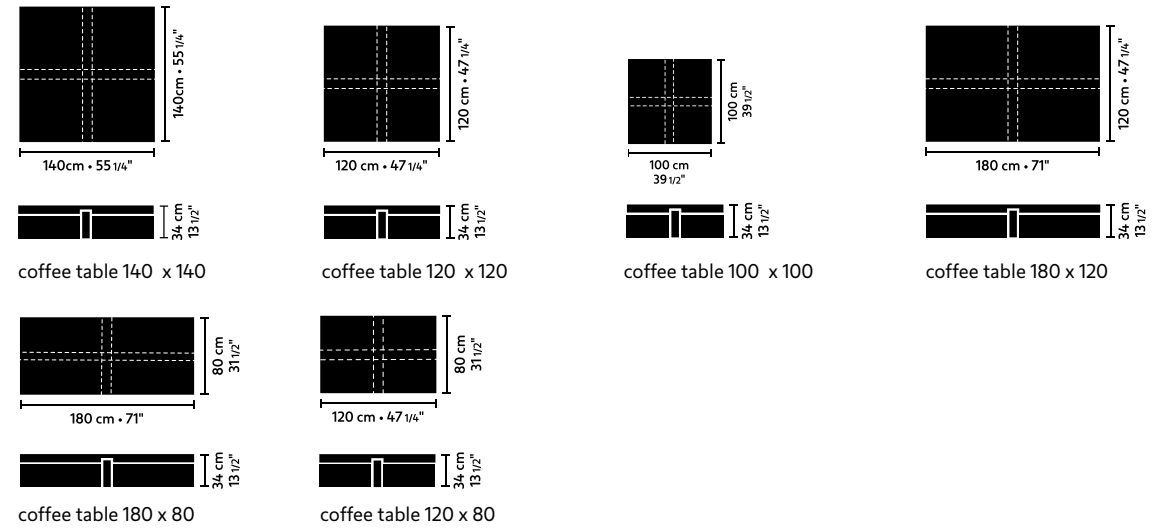

MADISON

SOFA

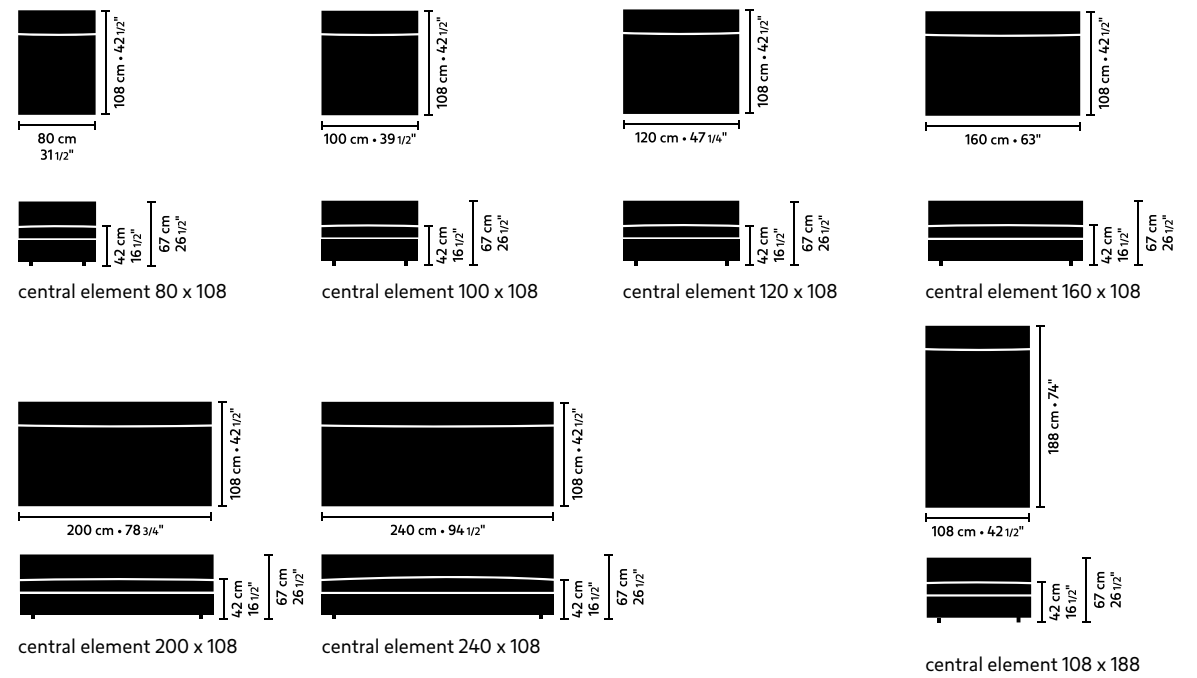

arm high 15 x 108 L/R
 arm low 30 x 108 L/R
 longchair arm L/R
 ottoman 108 x 108
 ottoman 160 x 108
 back cushion 66 x 28
 back cushion 66 x 45
 back cushion 48 x 48
 back cushion 58 x 58
 longchair arm L/R quilted
 ottoman 108 x 108 quilted
 ottoman 108 x 160 quilted
 terminal element 195 L/R
 Table 80 x 80
 Table 110 x 110
 Table 120 x 80

MANHATTAN

COFFEE TABLE

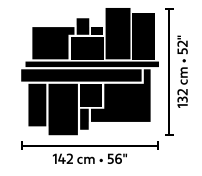

coffee table

MANTOVA

SIDE TABLES & CONSOLE

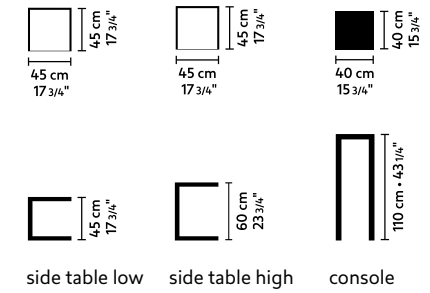

side table low side table high console

MARK

DINING CHAIR

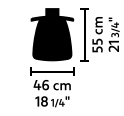

dining chair

MARK

DINING TABLE

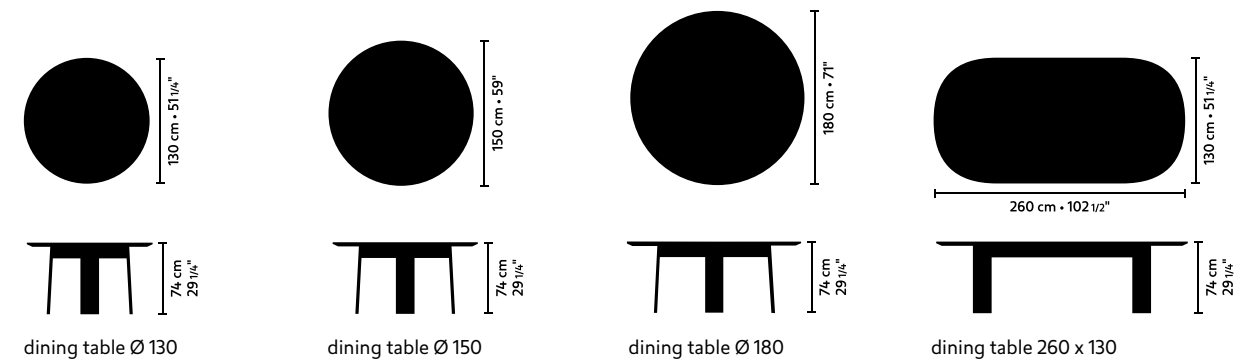

dining table Ø 130 dining table Ø 150 dining table Ø 180 dining table 260 x 130

MAURO



SOFA

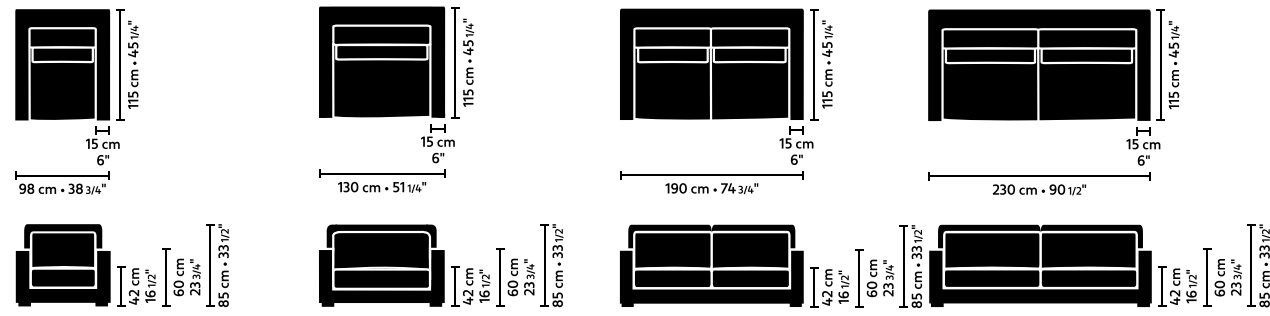

armchair loveseat 2,5 seater 3 seater

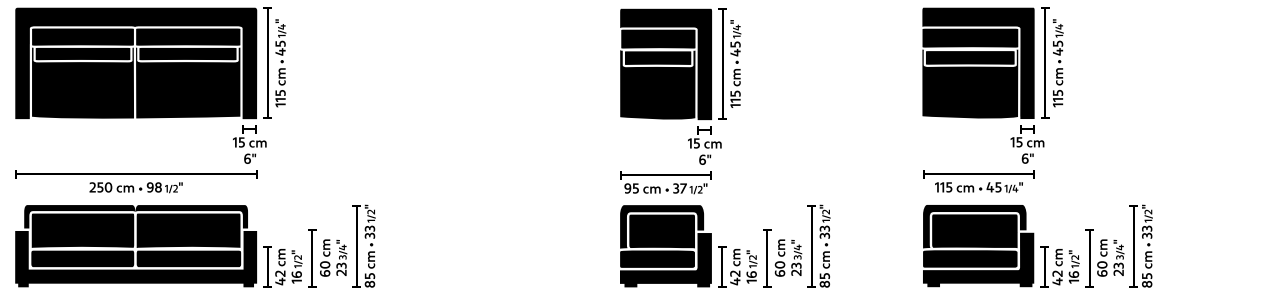

4 seater element 95 x 115 arm L/R element 115 x 115 arm L/R

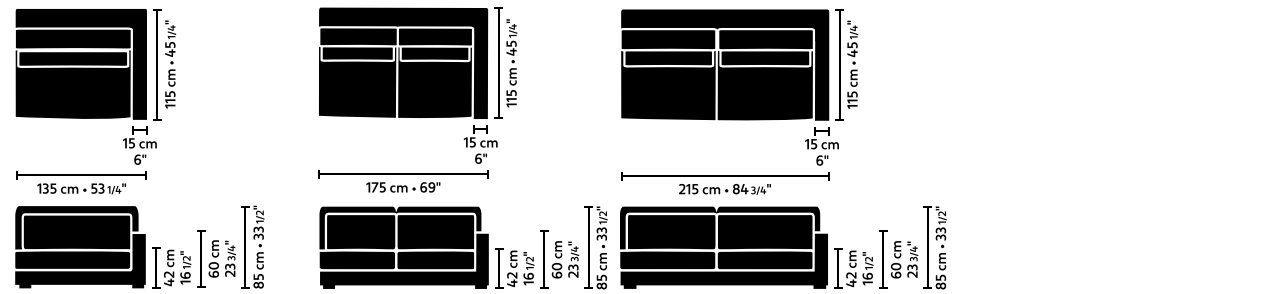

element 135 x 115 arm L/R element 175 x 115 arm L/R element 215 x 115 arm L/R

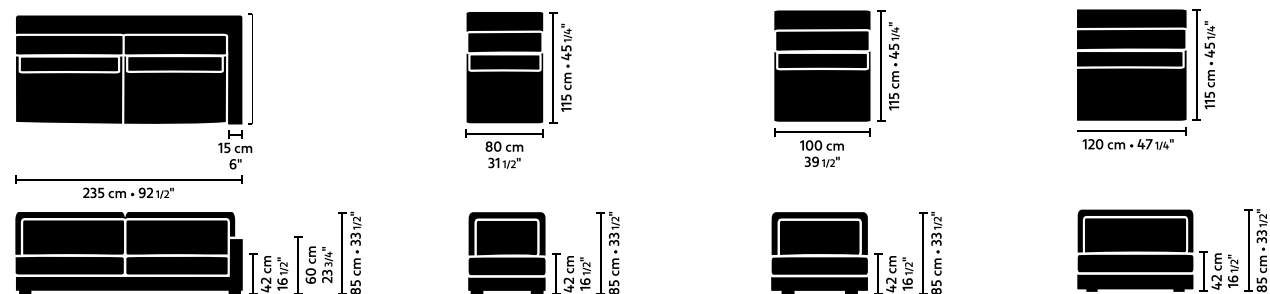

element 235 x 115 arm L/R central element 80 x 115 central element 100 x 115 central element 120 x 115

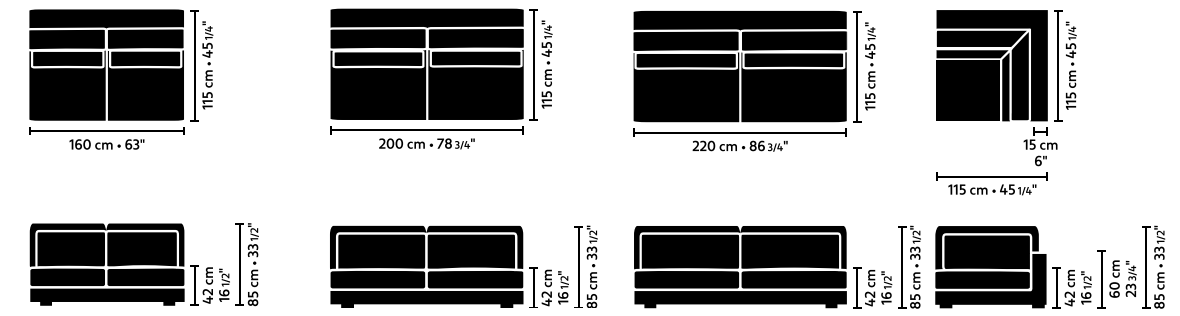

central element 160 x 115 central element 200 x 115 central element 220 x 115 corner L/R

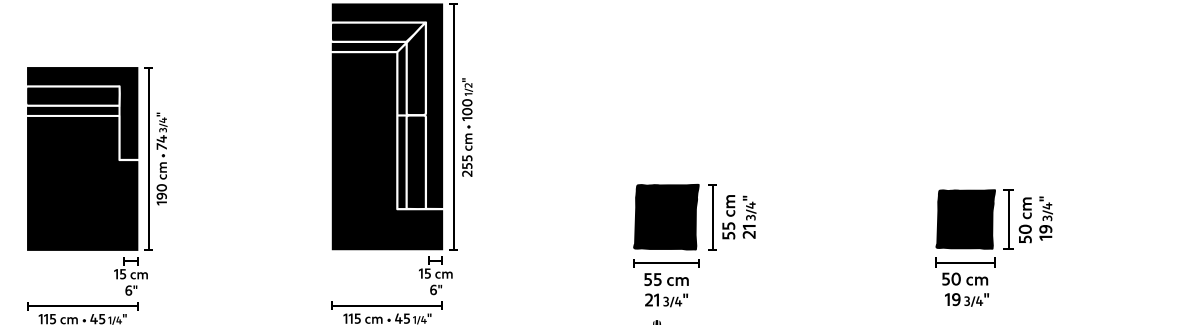

longchair arm L/R dormeuse arm L/R throw pillow drop pillow

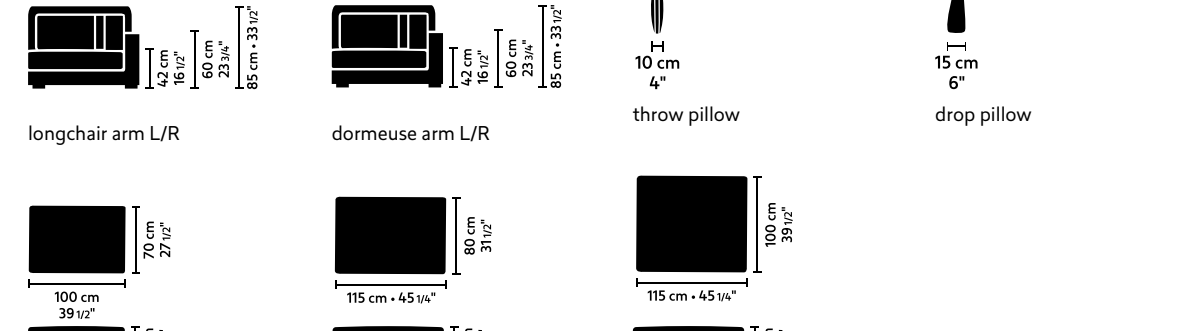

ottoman 100 x 70 ottoman 115 x 80 ottoman 115 x 100

METROPOLITAN



SOFA

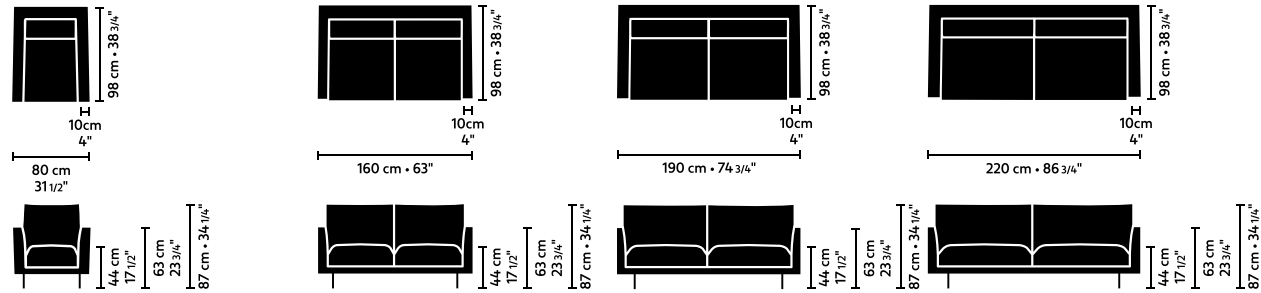

armchair undeeep 2 seater undeeep 2,5 seater undeeep 3 seater undeeep

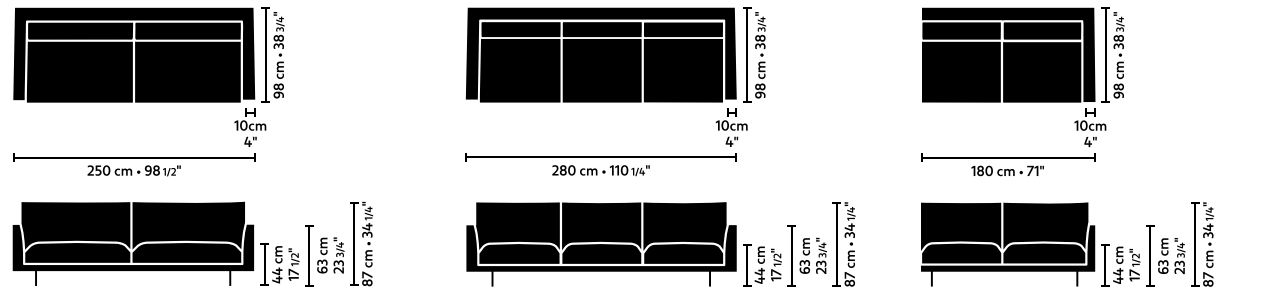

3,5 seater undeeep 4 seater undeeep element 180 x 98 arm L/R

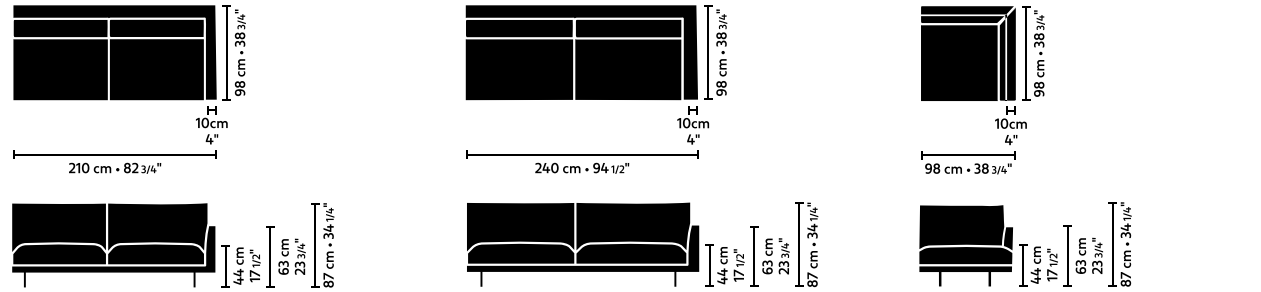

element 210 x 98 arm L/R element 240 x 98 arm L/R corner undeeep L/R

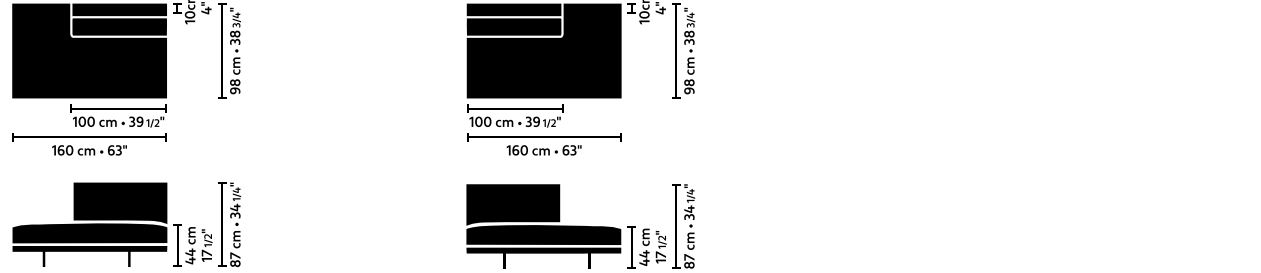

open end element undeeep left open end element undeeep right

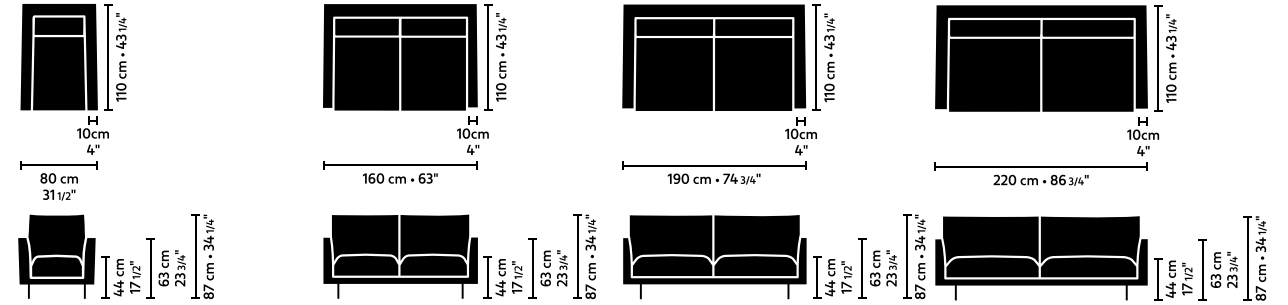

armchair deep 2 seater deep 2,5 seater deep 3 seater deep

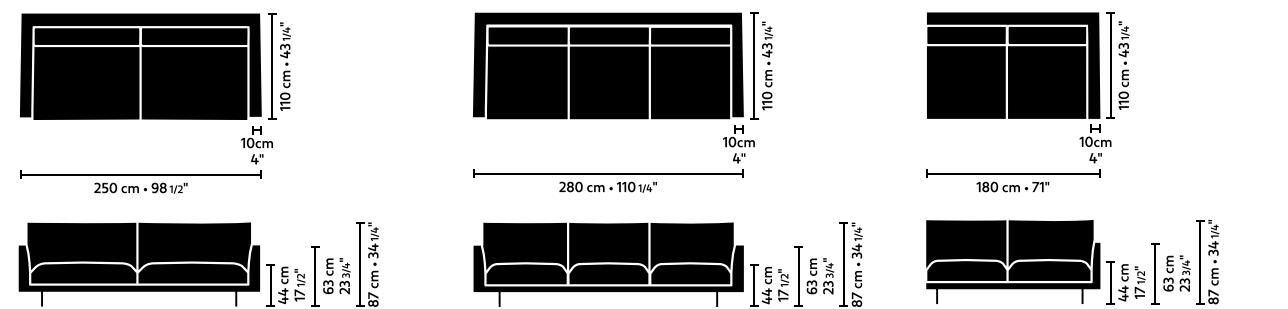

3,5 seater deep 4 seater deep element 180 x 110 arm L/R

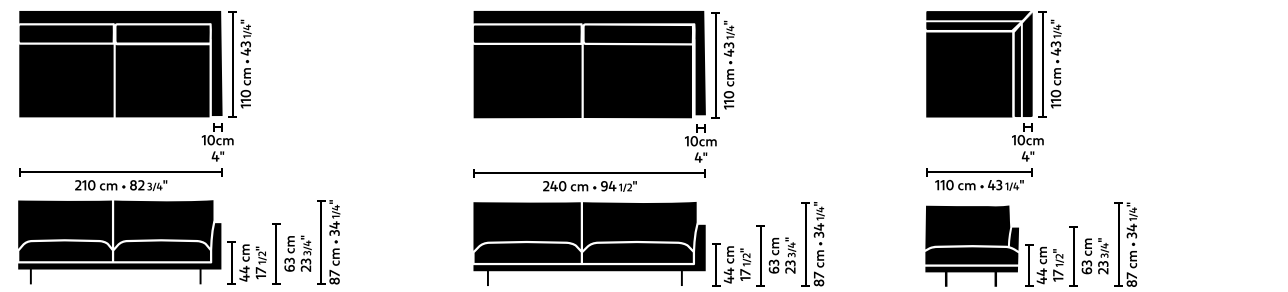

element 210 x 110 arm L/R element 240 x 110 arm L/R corner deep

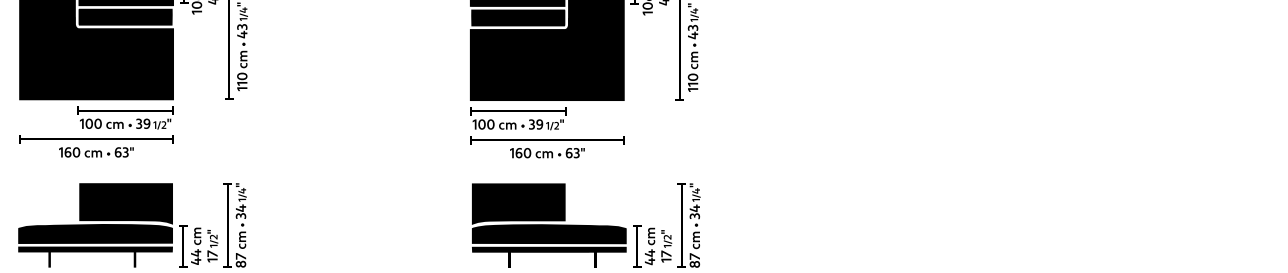

open end element deep left open end element deep right

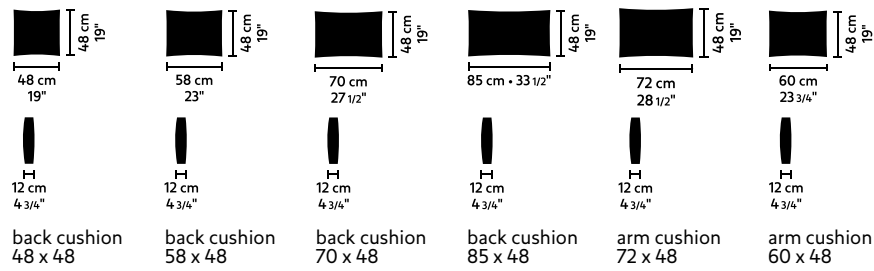
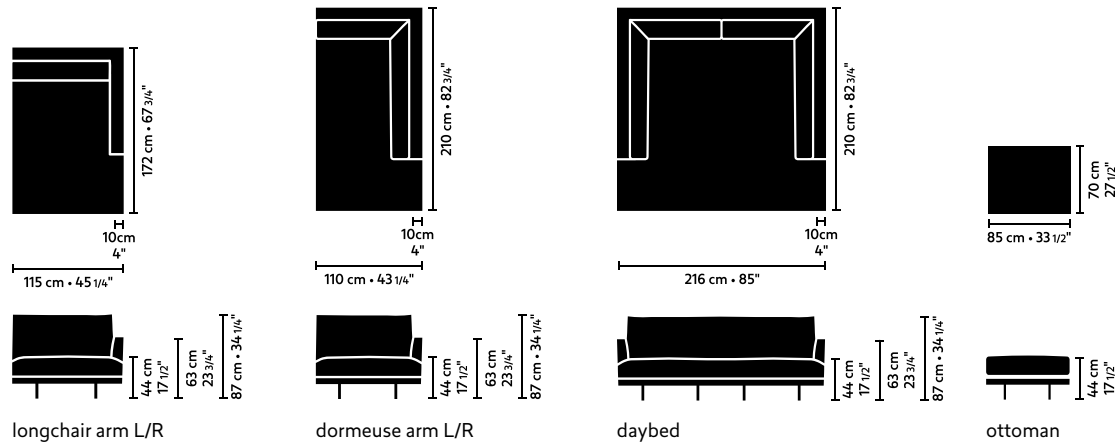

MILES CHAIR

ARMCHAIR

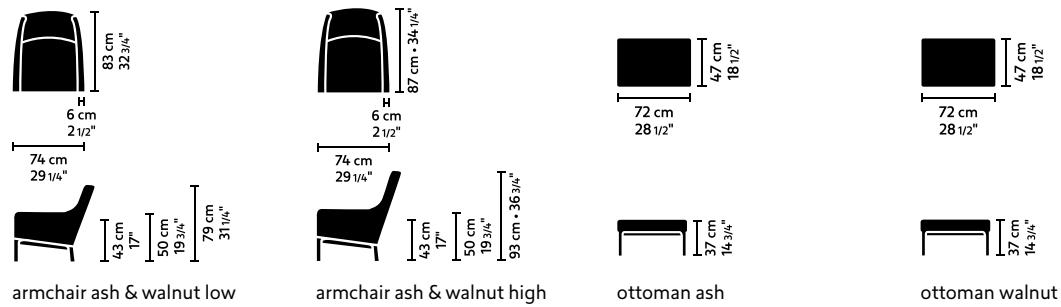

MILES TABLE

COFFEE TABLE

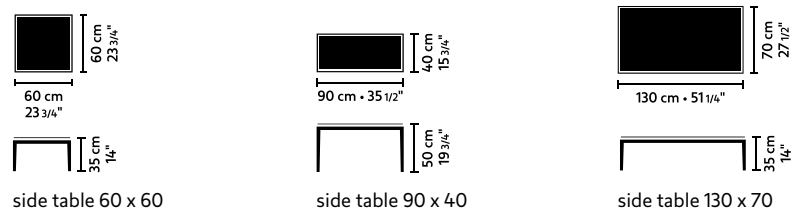

MODEL D

DINING CHAIR

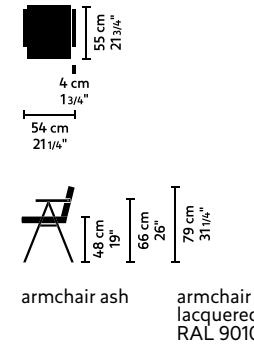

MORENO

SOFA

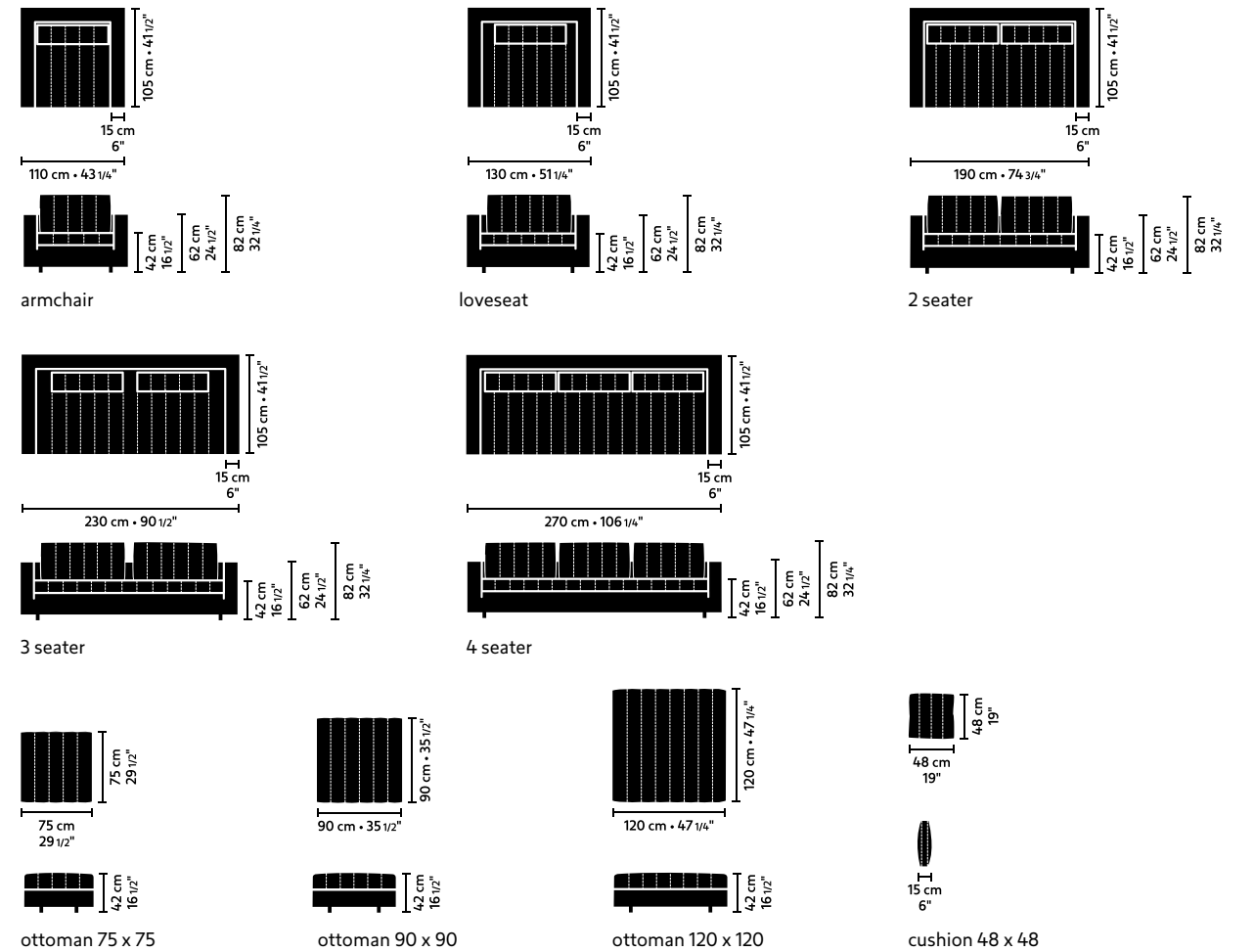

NJOY XL



SOFA

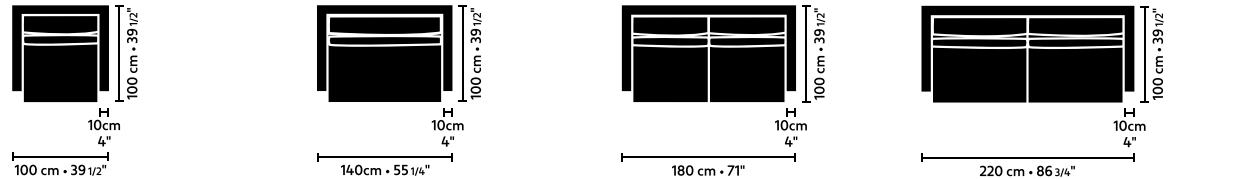

armchair loveseat 2,5 seater 3 seater

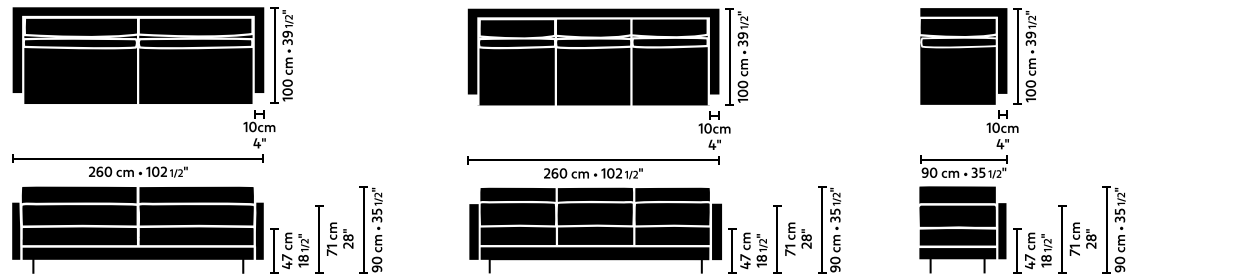

4 seater - 2 cushions 4 seater - 3 cushions element 90 x 100 arm L/R

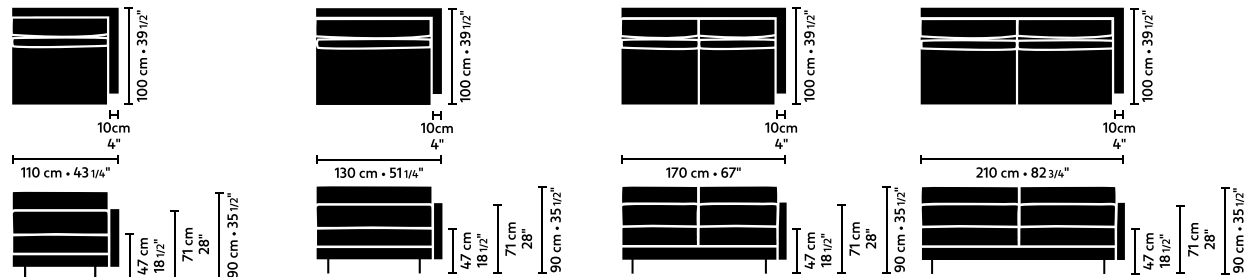

element 110 x 100 arm L/R element 130 x 100 arm L/R element 170 x 100 arm L/R element 210 x 100 arm L/R

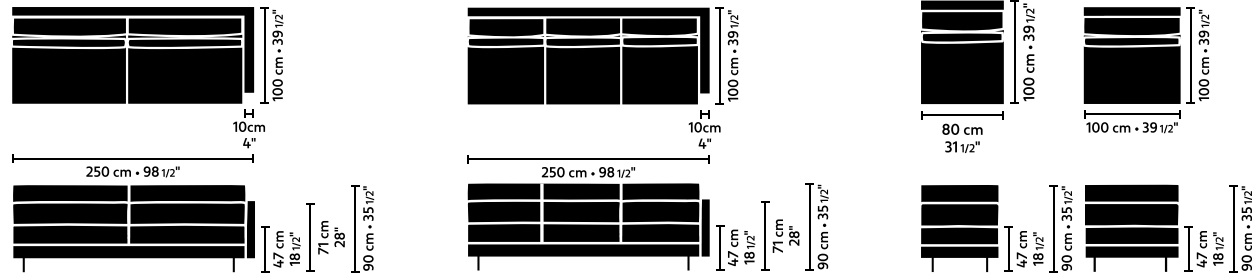

element 250 x 100 arm L/R - 2 cushions element 250 x 100 arm L/R - 3 cushions central element 80 x 100 central element 100 x 100

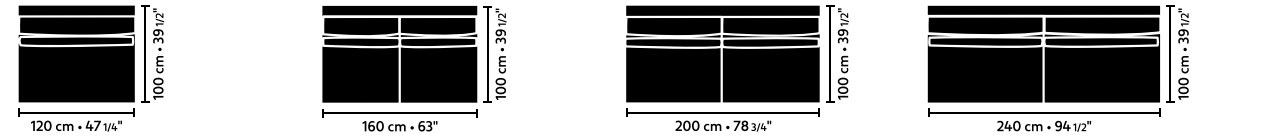

central element 120 x 100 central element 160 x 100 central element 200 x 100 central element 240 x 100 - 2 cushions

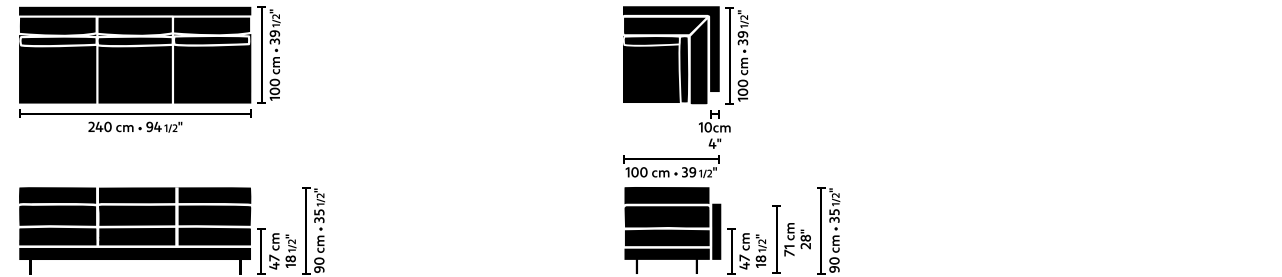

central element 240 x 100 - 3 cushions corner L/R

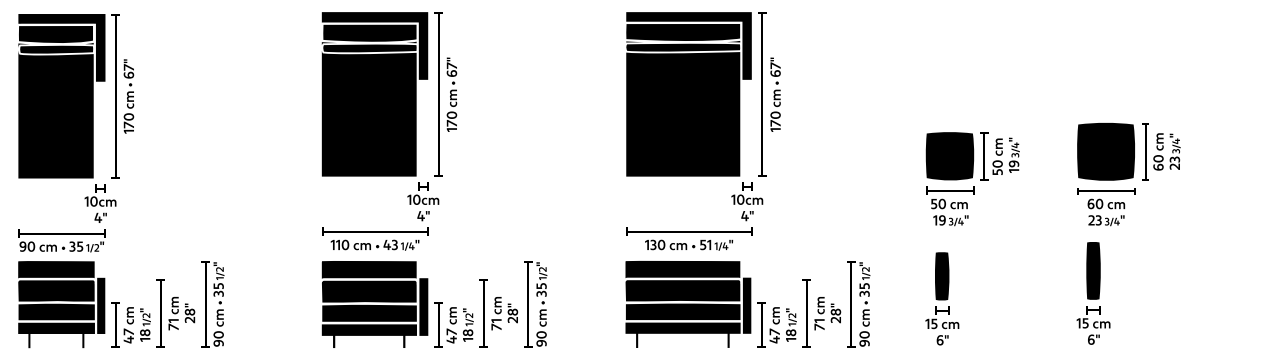

longchair 90 x 170 arm L/R longchair 110 x 170 arm L/R longchair 130 x 170 arm L/R throw pillow 50 x 50 throw pillow 60 x 60

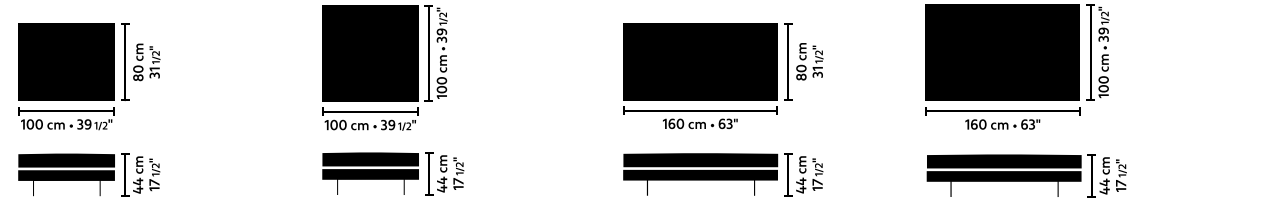

ottoman 100 x 80 ottoman 100 x 100 ottoman 160 x 80 ottoman 160 x 100

NUREYEV

CABINET

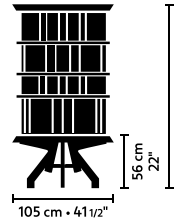
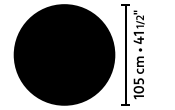

bookcase



OBI



COFFEE TABLE & SIDE TABLE



tray table Ø 55



tray table Ø 65



side table Ø 55

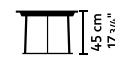

side table Ø 65

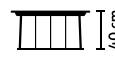

coffee table Ø 82

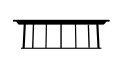

coffee table Ø 100



coffee table Ø 115



coffee table Ø 131

OISEAU



DINING CHAIR & DINING BENCH & ARMCHAIR

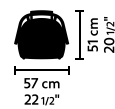

dining chair low

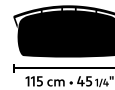

dining bench low 115 x 54

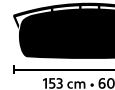

dining bench low 153 x 56

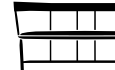
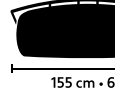

dining bench low 155 x 60

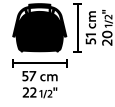

dining chair high

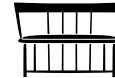
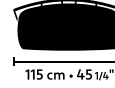

dining bench high 115 x 54

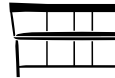

dining bench high 153 x 56

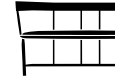

dining bench high 155 x 60

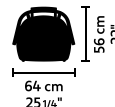

armchair

OISEAU



COFFEE TABLE & DINING TABLE

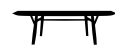

coffee table low 108 x 108



coffee table high 108 x 108



dining table low 108 x 108

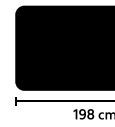

dining table low 198 x 88



dining table low 258 x 88



dining table high 108 x 108

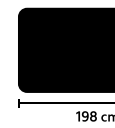

dining table high 198 x 88

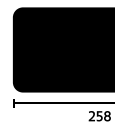

dining table high 258 x 88

PAVIA



DINING CHAIR

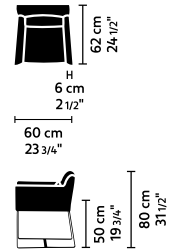

dining chair

PLEASURE



SOFA

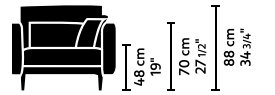
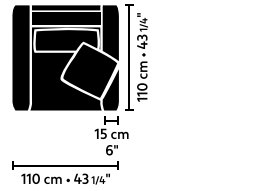

armchair

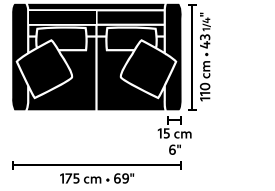

2,5 seater

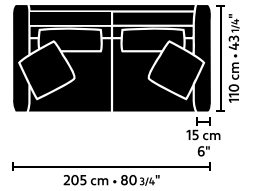

3 seater

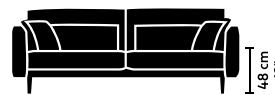
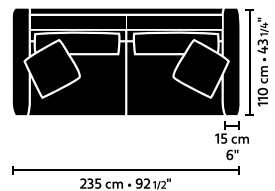

3,5 seater

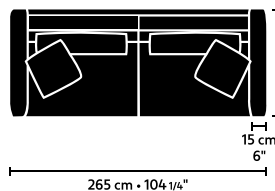

4 seater

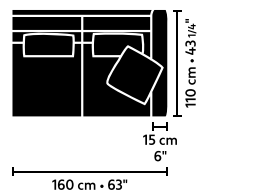

element 160 x 110 arm L/R

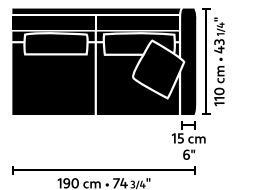

element 190 x 110 arm L/R

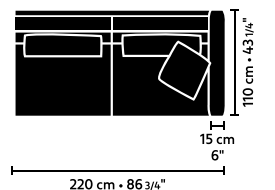

element 220 x 110 arm L/R

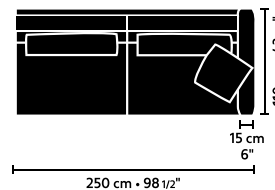

element 250 x 110 arm L/R

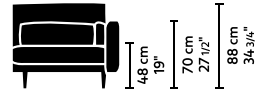
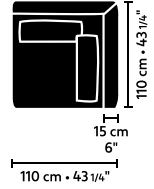

corner L/R

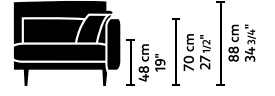
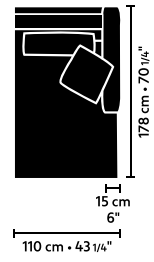

longchair arm L/R

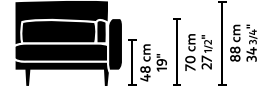
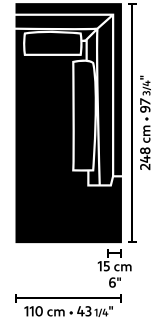

dormeuse arm L/R

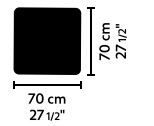

ottoman 70 x 70

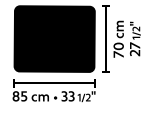

ottoman 85 x 70

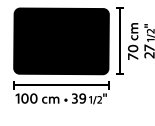

ottoman 100 x 70

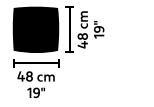

throw pillow
48 x 48



throw pillow
58 x 58

RECESS

SOFA

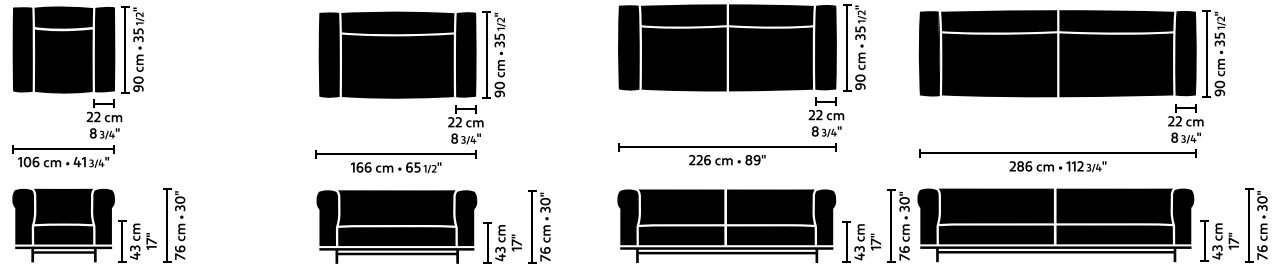

armchair 2 seater 3 seater 4 seater

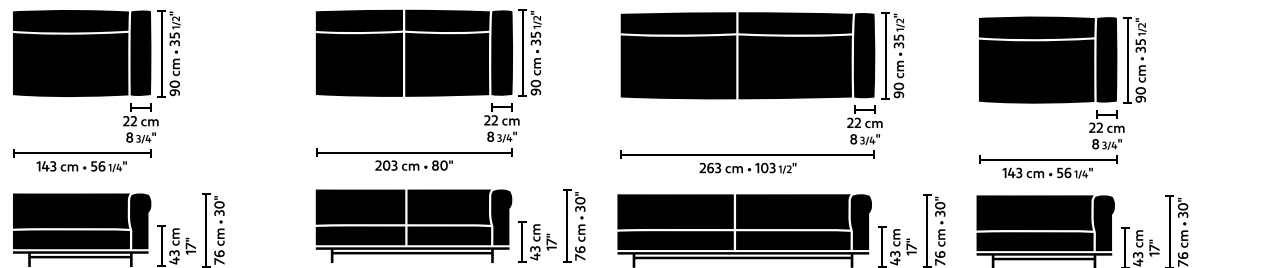

element 143 x 90 arm L/R element 203 x 90 arm L/R element 263 x 90 arm L/R corner 143 x 90 L/R

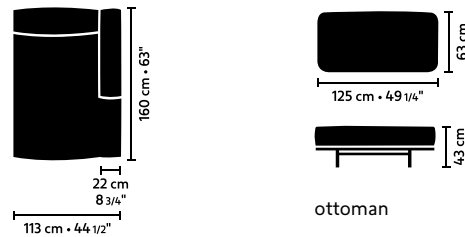

ottoman longchair arm L/R

RELAX

SOFA

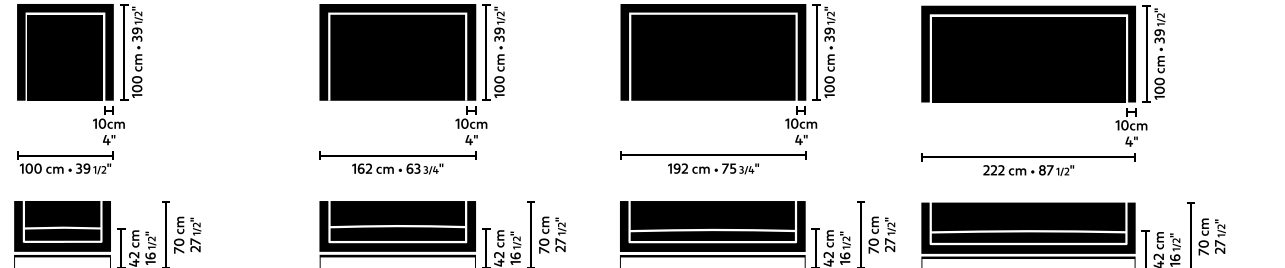

armchair 2 seater 3 seater 3,5 seater

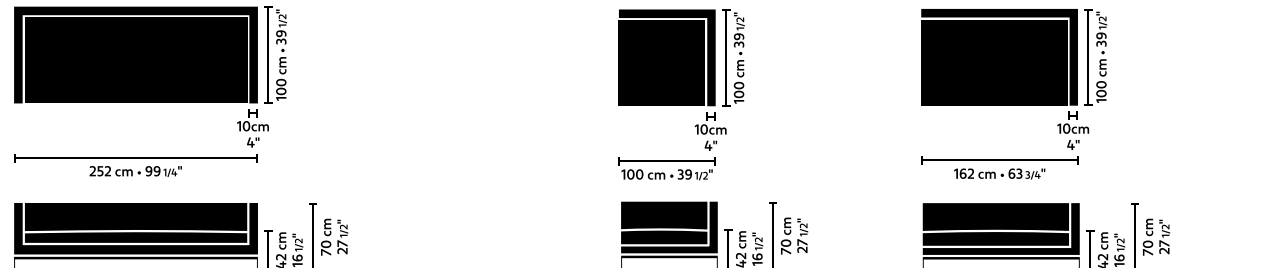

4 seater element 100 x 100 arm L/R element 162 x 100 arm L/R

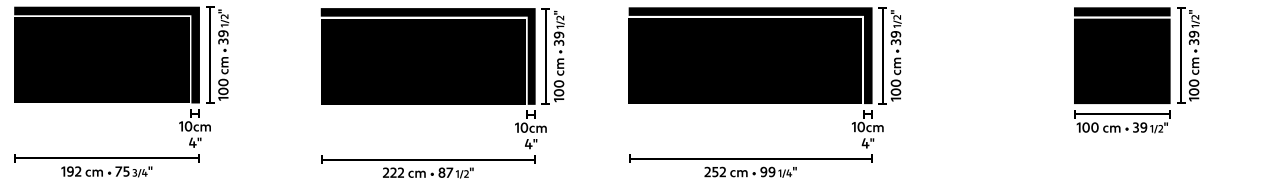

element 192 x 100 arm L/R element 222 x 100 arm L/R element 252 x 100 arm L/R central element 100 x 100

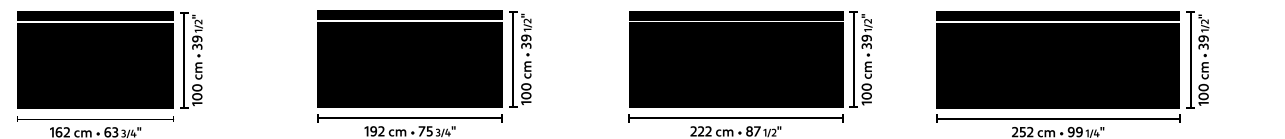

central element 162 x 100 central element 192 x 100 central element 222 x 100 central element 252 x 100

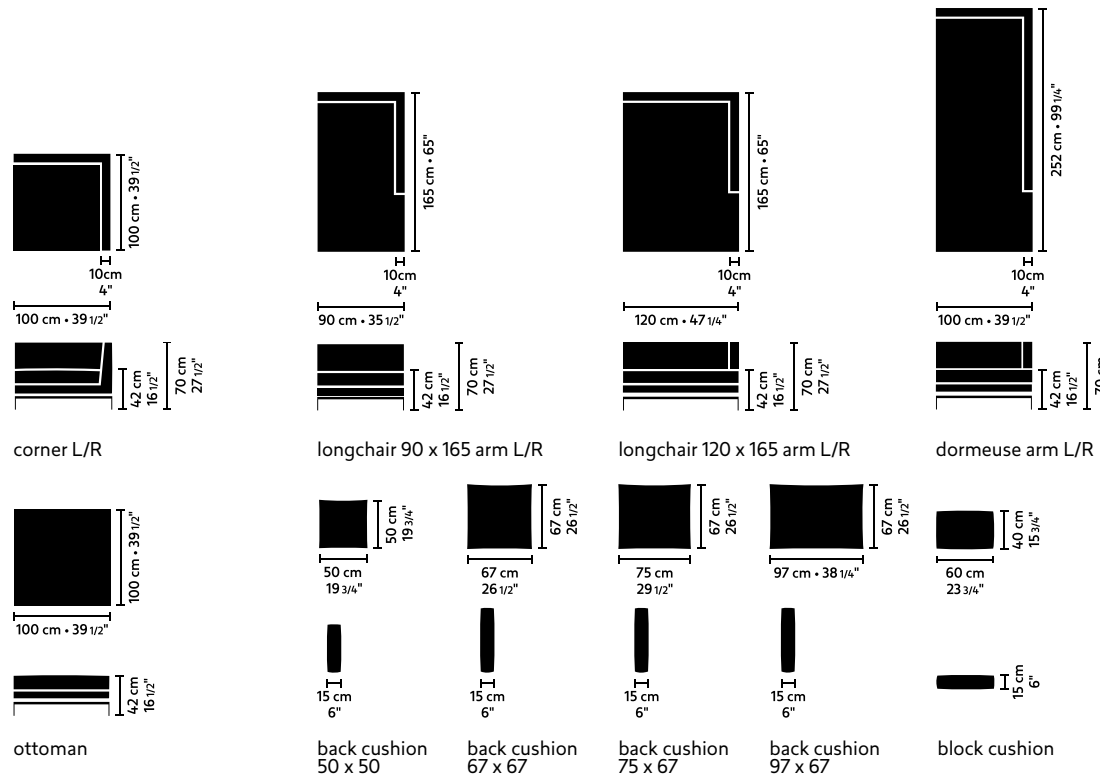

THE SICILIAN

DINING TABLE

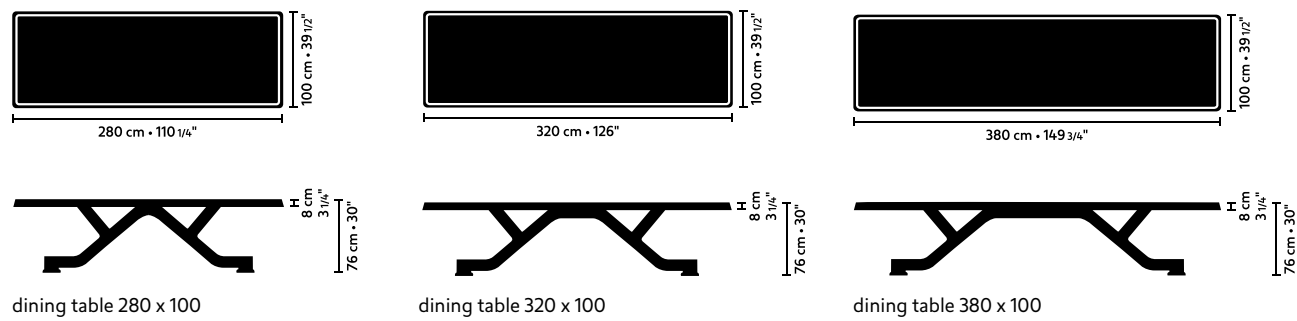

SOUTHAMPTON



SOFA

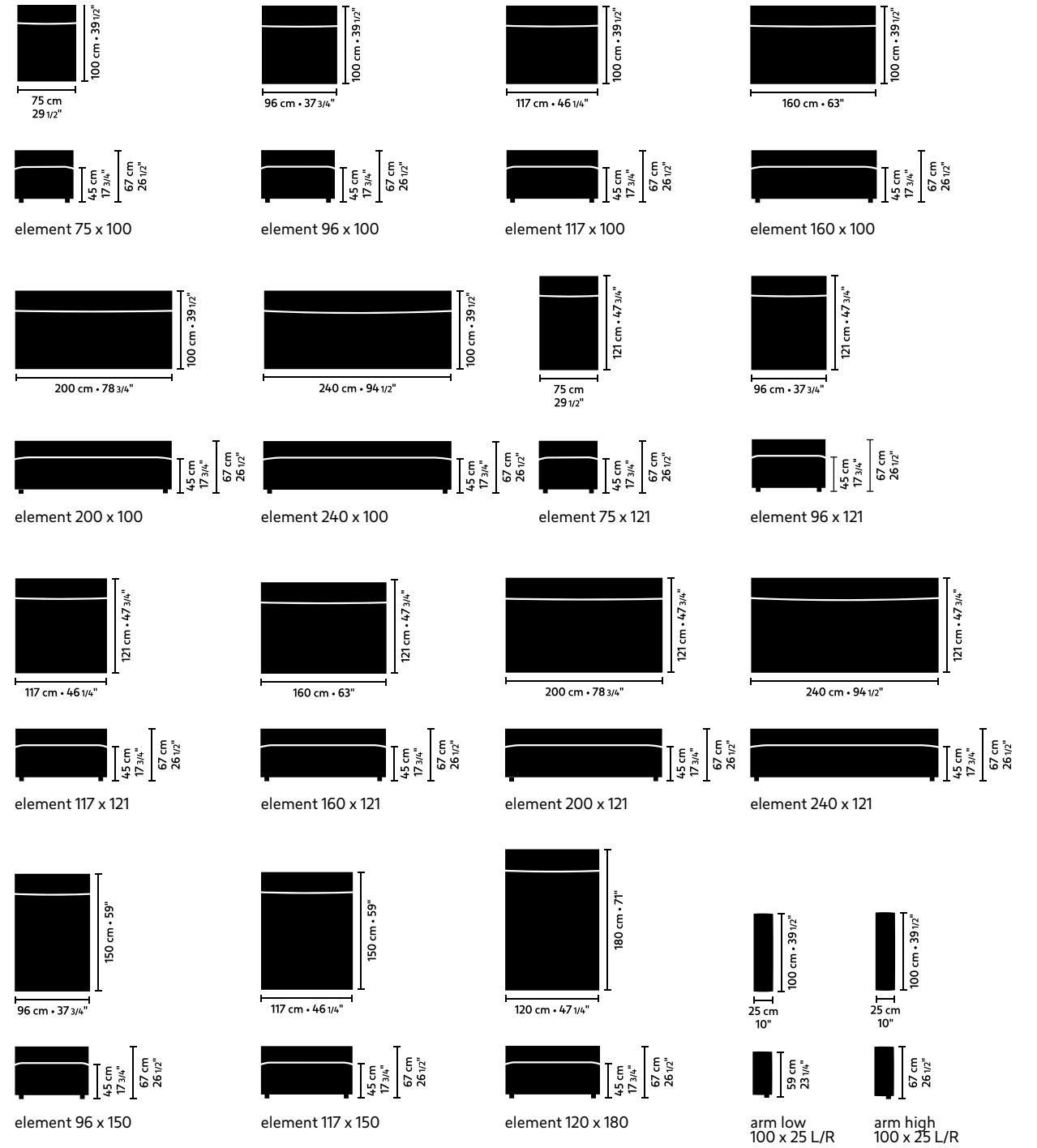

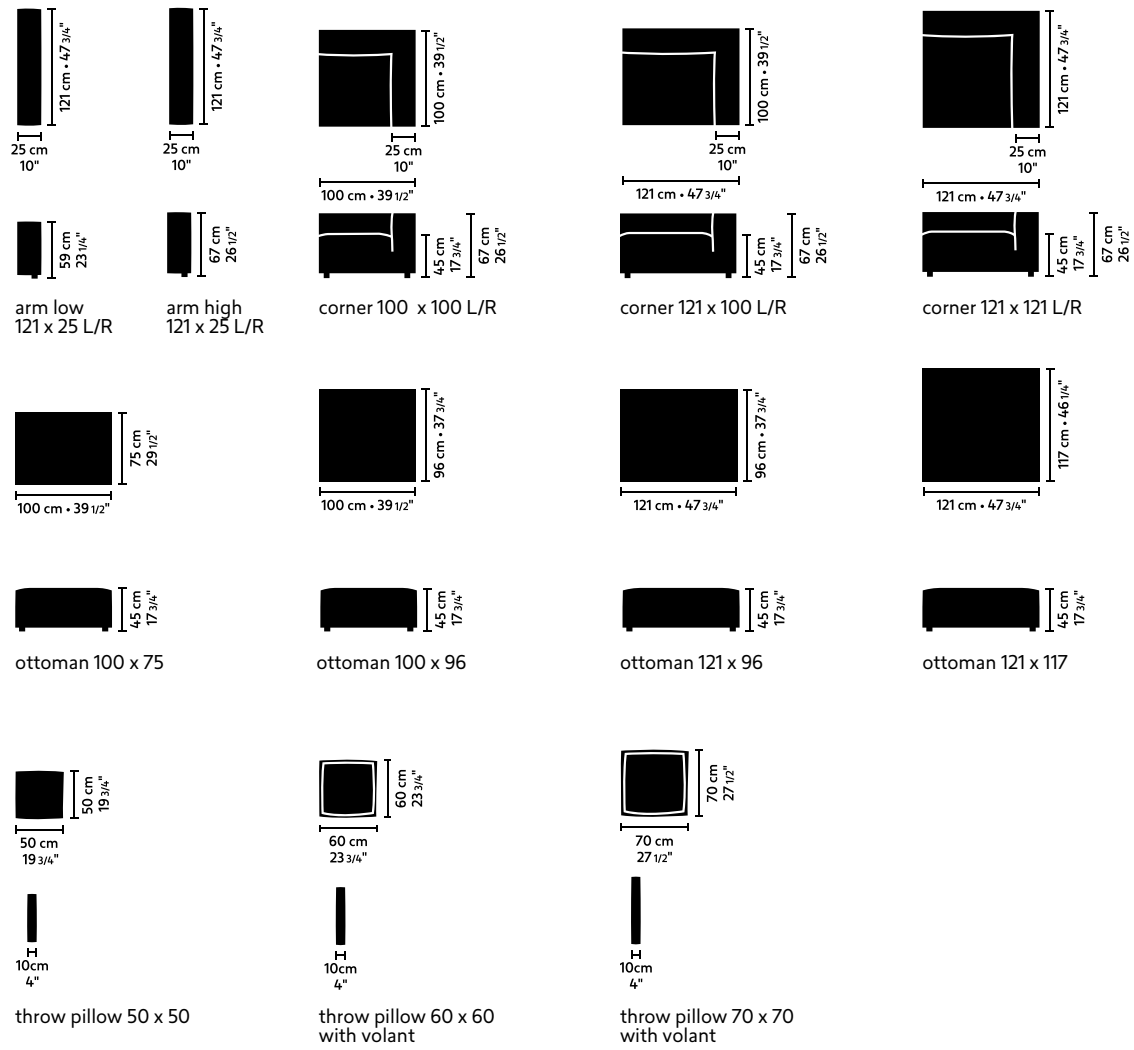

TERRACE



COFFEE TABLE

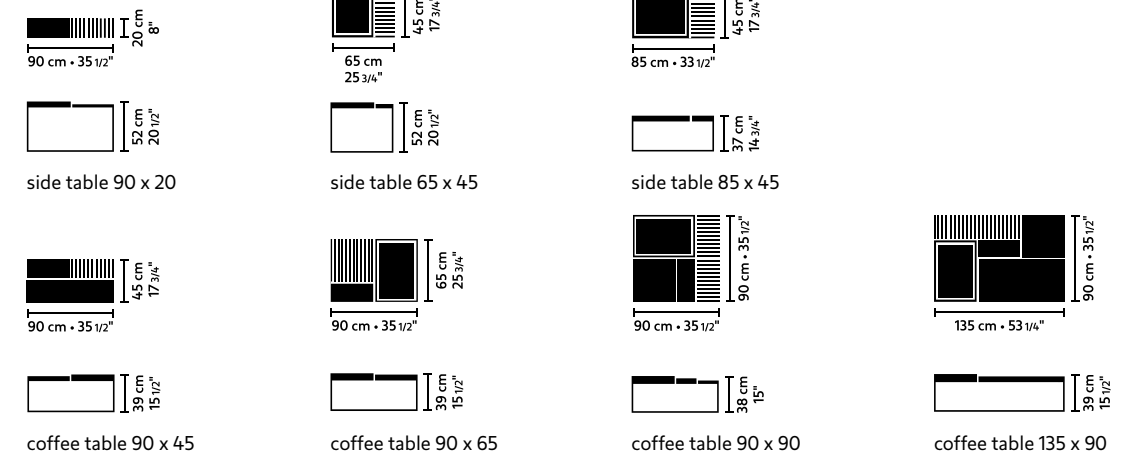

TULIPANI



DINING CHAIR

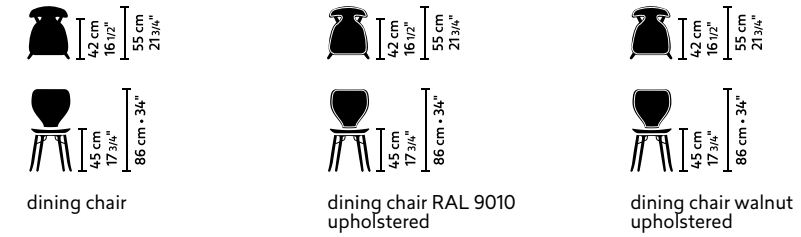

VANITY



COFFEE TABLE

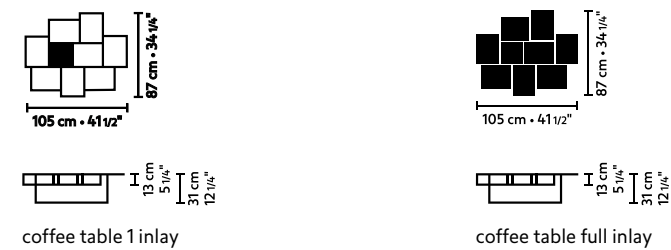

VNU
DINING TABLE

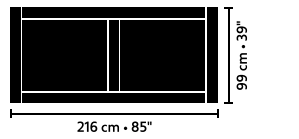

dining table 216 x 99

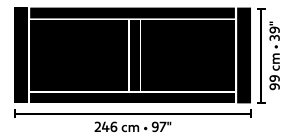

dining table 246 x 99

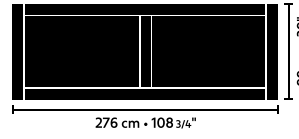

dining table 276 x 99

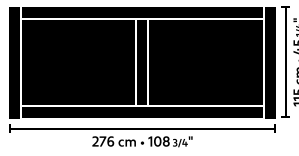

dining table 276 x 115

LINTELOO
THE
FEEL
GOOD
FACTOR



The feel good **factor**

Showroom / Head Office
Johannes Postlaan 6
3705 LN Zeist
The Netherlands

T + 31 (0)30 212 2110
info@linteloo.com

www.linteloo.com